



Mobile Printing Systems CPCL Programming Manual

Proprietary Statement

This manual contains proprietary information of Zebra Technologies Corporation and its subsidiaries ("Zebra Technologies"). It is intended solely for the information and use of parties operating and maintaining the equipment described herein. Such propriety information may not be used, reproduced, or disclosed to any other parties for any other purpose without the expressed written permission of Zebra Technologies.

Product Improvements

Continuous improvement of products is a policy of Zebra Technologies. All specifications and designs are subject to change without notice.

FCC Compliance Statement

Digital apparatus has been tested and found to comply with the limits for a Class B Digital Device, pursuant to Part 15 of the FCC Rules. These limits are designed to provide reasonable protection against harmful interference when the equipment is operated in a commercial environment. This equipment generates, uses, and can radiate radio frequency energy and, if not installed and used in accordance with the product manuals, may cause harmful interference to radio communications. Operation of this equipment in a residential area is likely to cause harmful interference in which case the user will be required to correct the interference at his own expense.

The user is cautioned that any changes or modifications not expressly approved by Zebra Technologies could void the user's authority to operate the equipment. This unit was tested with shielded cables on the peripheral devices. Shielded cables must be used with the unit to insure compliance.

WARNING: EXPOSURE TO RADIO FREQUENCY RADIATION ON SOME MODELS. TO CONFORM TO FCC RF EXPOSURE REQUIREMENTS THIS DEVICE SHALL BE USED IN ACCORDANCE WITH THE OPERATING CONDITIONS AND INSTRUCTIONS LISTED IN THIS UNIT'S USER'S MANUAL.

Canadian DOC Compliance Statement

Digital apparatus does not exceed the Class A limits for radio noise emissions from digital apparatus as set out in the radio interference regulations of the Canadian Department of Communications.

Liability Disclaimer

Zebra Technologies takes steps to assure that its published Engineering specifications and manuals are correct; however, errors do occur. Zebra Technologies reserves the right to correct any such errors and disclaims liability resulting therefrom.

Limitation of Liability

In no event shall Zebra Technologies or anyone else involved in the creation, production or delivery of the accompanying product (including hardware and software) be liable for any damages whatsoever (including, without limitation, consequential damages including loss of business profits, business interruption or loss of business information) arising out of the use of or the results of use of or inability to use such product, even if Zebra Technologies has been advised of the possibility of such damages. Some jurisdictions do not allow the exclusion or limitation of incidental or consequential damages, so the above limitation or exclusion may not apply to you.

Copyrights

The copyrights in this manual and the label printer described therein are owned by Zebra Technologies. All rights are reserved. Unauthorized reproduction of this manual or the software in the label printer may result in imprisonment of up to one year and fines of up to \$10,000 (17 U.S.C.506). Copyright violators may be subject to civil liability.

©2003 ZIH Corp. All trademarks and registered trademarks are property of their respective owners. All rights reserved.

TABLE OF CONTENTS

PROGRAMMING INTRODUCTION	P1-1
PROGRAMMING LANGUAGE EMULATION	P1-1
PROGRAMMING LANGUAGE RECOMMENDATIONS	P1-2
GETTING PRINTER INFORMATION	P1-3
GETTING PRINTER INFORMATION EXAMPLE	P1-4
COMMUNICATIONS DIAGNOSTICS MODE	P1-7
LABEL COORDINATE SYSTEM	P1-8
LABEL VISTA™	P1-9
PRINTER COMMANDS	P2-1
PRINTER COMMANDS	P2-2
PRINT COMMAND	P2-3
FORM COMMAND	P2-4
JOURNAL COMMAND	P2-5
UNITS COMMANDS	P2-6
USING COMMENTS	P2-8
TEXT	P3-1
RESIDENT FONT SAMPLES	P3-1
TEXT COMMANDS	P3-4
USING FONT GROUPS	P3-6
TEXT CONCATENATION COMMANDS	P3-8
MULTILINE (ML) COMMANDS	P3-10
COUNT COMMAND	P3-12
SETMAG COMMAND	P3-14
SCALABLE TEXT	P4-1
SCALE-TEXT COMMANDS	P4-2
SCALE-TO-FIT COMMANDS	P4-4
SCALABLE CONCATENATION COMMANDS	P4-6
ROTATE COMMANDS	P4-8
LINEAR BAR CODES	P5-1
INTRODUCTION	P5-1
UPC AND EAN/JAN BAR CODES	P5-3
CODE 39 OR CODE 3 OF 9 BAR CODES	P5-6
CODE 93 OR CODE 9 OF 3 BAR CODES	P5-8
INTERLEAVED 2 OF 5 BAR CODES	P5-8
CODE 128 AND THE UCC-128 SHIPPING STANDARD	P5-9
CODABAR	P5-11
MSI PLESSEY BAR CODES	P5-12
POSTNET AND FACING IDENTIFICATION MARKS	P5-13
BAR CODE COMMANDS	P5-15
BARCODE COMMAND	P5-16
BARCODE-TEXT COMMAND	P5-18
COUNT COMMAND	P5-20
TWO-DIMENSIONAL BAR CODES	P6-1
INTRODUCTION	P6-1

TABLE OF CONTENTS (continued)

PDF417	P6-2
MAXICODE	P6-2
TWO-DIMENSIONAL BAR CODE COMMANDS	P6-3
PDF417 (PORTABLE DATA FILE)	P6-4
GRAPHICS	P7-1
BOX COMMAND	P7-1
LINE COMMANDS	P7-2
INVERSE-LINE COMMANDS	P7-4
PATTERN COMMAND	P7-6
GRAPHICS COMMANDS	P7-8
PCX COMMANDS	P7-10
ADVANCED COMMANDS	P8-1
CONTRAST COMMAND	P8-1
TONE COMMAND	P8-2
JUSTIFICATION COMMANDS	P8-3
PAGE-WIDTH COMMAND	P8-4
PACE COMMAND	P8-6
NO-PACE COMMAND	P8-9
WAIT COMMAND	P8-10
REWIND COMMAND	P8-11
TENSION COMMANDS	P8-12
SPEED COMMAND	P8-13
SETSP COMMAND	P8-14
ON-OUT-OF-PAPER COMMAND	P8-15
ON-FEED COMMAND	P8-16
PREFEED COMMAND	P8-18
POSTFEED COMMAND	P8-19
PRESENT-AT COMMAND	P8-20
COUNTRY / CODE PAGE COMMAND	P8-22
USING FORMAT FILES	P8-24
BEEP COMMAND	P8-27
CUT COMMAND	P8-28
PARTIAL-CUT COMMAND	P8-29
CUT-AT COMMAND	P8-30
MCR COMMANDS	P8-31
LINE PRINT MODE	P9-1
INTRODUCTION	P9-1
SPECIAL COMMANDS USING THE UTILITY FUNCTION	P9-2
UNITS COMMANDS	P9-3
SETLP COMMAND	P9-4
SETLF COMMAND	P9-5
MOVING WITH X AND Y COORDINATES	P9-6
LMARGIN COMMAND	P9-7
SETBOLD COMMAND	P9-8
SETSP COMMAND	P9-9
PAGE-WIDTH COMMAND	P9-10
PAGE-HEIGHT COMMAND	P9-10

SPECIAL ASCII CHARACTERS	P9-10
SETFF COMMAND	P9-11
SET-TOF COMMAND	P9-12
TEARING OR CUTTING THE PAPER	P9-14
BAR CODES, GRAPHICS AND LINES	P9-15
SETLP-TIMEOUT COMMAND	P9-16
DESIGNING A RECEIPT	P9-16
ADVANCED UTILITIES	P10-1
VERSION UTILITY	P10-2
CHECKSUM UTILITY	P10-3
DEL UTILITY	P10-4
DIR UTILITY	P10-5
DEFINE-FILE (DF) UTILITY	P10-6
TYPE UTILITY	P10-8
BAUD UTILITY	P10-9
COUNTRY / CODE-PAGE UTILITY	P10-10
ANNOUNCE UTILITY	P10-12
TIMEOUT UTILITY	P10-14
TIMEOUT UTILITY EXAMPLE	P10-14
BEEP COMMAND	P10-15
BEEP COMMAND EXAMPLE	P10-15
ON-LOW-BATTERY COMMAND	P10-16
LT COMMAND	P10-17
LT COMMAND EXAMPLES	P10-17
SET-TIME UTILITY	P10-18
GET-TIME UTILITY	P10-19
SET-DATE UTILITY	P10-20
GET-DATE UTILITY	P10-21
PRINTING A TIME STAMP	P10-22
PRINTING A DATE STAMP	P10-23
MAGNETIC CARD READER (MCR) COMMAND	P10-24
MCR-QUERY COMMAND	P10-30
MCR-CAN COMMAND	P10-32
S-CARD COMMAND	P10-33
S-CARD COMMAND EXAMPLES	P10-36
DENSO BHT COMMANDS	P10-37
SETTING THE DATA FORMAT	P10-37
IR OR CABLE INTERFACE SELECTION	P10-39
BHT-BAUD COMMAND	P10-39
SETTING THE MODE FOR IR DATA TRANSMISSION	P10-39
CONFIGURING THE BHT FOR IR TRANSMISSION	P10-40
BHT-IR FILE TRANSMISSION	P10-41
CONFIGURING THE BHT FOR CABLE TRANSMISSION	P10-42
LOADING A .DAT FILE INTO THE BHT	P10-43
INTERRUPTED TRANSMISSIONS	P10-44
EXAMPLE .DAT FILE	P10-45
SRF-ACCESS AND END-SRF-ACCESS COMMANDS	P10-46
BHT-BAUD COMMAND	P10-47
BHT MODE COMMANDS	P10-48

TABLE OF CONTENTS (continued)

BHT PROTOCOL COMMAND	P10-52
PRINTER ESCAPE COMMANDS	P11-1
SET AND READ CODE COMMAND	P11-1
PRINTER ESCAPE COMMANDS FORMAT	P11-2
STATUS/INFORMATION	P11-3
USER LABEL COUNT	P11-5
POWER OFF COMMAND	P11-5
WIRELESS NETWORK PRINTERS	P12-1
INTRODUCTION	P12-1
NETWORK PRINTER SAFETY CONSIDERATIONS	P12-1
LAN COMMAND	P12-1
SETTING THE IP ADDRESS FOR NETWORK PRINTERS	P12-7
LAN COMMAND RESPONSE	P12-8
NETWORK PRINTER TROUBLESHOOTING	P12-9
WIRELESS LAN REPORT EXAMPLE	P12-10
PROGRAMMING FOR THE DISPLAY OPTION	P13-1
INTRODUCTION:	P13-1
EXAMPLE 1:	P13-1
EXAMPLE 2:	P13-5
TABLE 1: WML TAGS	P13-7
CONFIGURATION/CONTROL COMMANDS	P14-1
INTRODUCTION	P14-1
COMMAND FORMAT	P14-1
COMMANDS / PARAMETERS	P14-3
BLUETOOTH™ PARAMETERS	P14-5
COMM PORT PARAMETERS	P14-11
DEVICE PARAMETERS	P14-13
DISPLAY PARAMETERS	P14-15
FILE PARAMETERS	P14-17
PRINTER MECHANISM PARAMETERS	P14-19
INPUT PARAMETER	P14-22
MEDIA PARAMETERS	P14-24
MEMORY PARAMETERS	P14-27
ODOMETER PARAMETERS	P14-28
POWER PARAMETERS	P14-32
TEST FUNCTION PARAMETERS	P14-36
NETWORKING PARAMETERS	P14-37
WLAN PARAMETERS	P14-59
ZEBRA QL PRINTER MIRROR PROCESS	P14-78
VIRTUAL PRIVACY NETWORK (VPN) COMMANDS	P14-86
PRINTER CONFIGURATION AND SETUP	P15-1
MINIATURE PRINTER UTILITIES PROGRAM	P15-1
USING LABEL VISTA TO SEND FILES	P15-4
POWER MANAGEMENT	P15-7
BATCH FILES	P15-10
RUN.BAT COMMAND/FILE	P15-11

RE-RUN COMMAND	P15-12
GAP-SENSE & BAR-SENSE COMMANDS	P15-13
INDEX	A-1
APPENDIX A- FREQUENTLY ASKED QUESTIONS	A-14
APPENDIX B- INTERFACE CABLES	A-19
APPENDIX C- CHARACTER TABLES	A-23
APPENDIX D- FONT INFORMATION	A-26
APPENDIX E- BARCODE QUICK REFERENCE	A-30
APPENDIX F- PRODUCT SUPPORT	A-32

Programming Section

PROGRAMMING INTRODUCTION

This manual details the various commands in the CPCL language which allow the programmer to utilize the built in text, graphics, bar code printing and communications capabilities of Zebra mobile printers. The following notation conventions are used throughout this manual::

- `{ }` Required item
- `[]` Optional item
- `()` Abbreviated command
- `< >` Literal item

A space character is used to delimit each field in a command line.

Many commands are accompanied by examples of the command in use. After the word 'Input' in each example, the file name of that example will appear in parentheses.

This manual can also be found on the Accessories CD (Part Number 46984) available from Zebra.

PROGRAMMING LANGUAGE EMULATION

Zebra Mobile Printers can emulate the EPL II and ZPL programming languages used by other types of Zebra printers. Printers using emulation must be configured with more memory and have a special emulation program loaded. For more information on the appropriate uses of these languages, refer to the language comparison chart below:

continued on next page

PROGRAMMING LANGUAGE RECOMMENDATIONS

Language	Native in	Recommended Use
CPCL	Cameo™, Encore™ QL™ and older Comtec models	<ul style="list-style-type: none"> • In new installations of mobiles, where CPCL is easily integrated into the host application • When older Comtec models are being upgraded- so that the customer can use existing application without code modifications
ZPL (emulation available on QL series)	PA/PT™Series mobile printers, Zebra High Performance/ Industrial /Commercial printers, R-140™ RFID printer, LP/TLP 2844-Z and PAX™ applicator printers	<ul style="list-style-type: none"> • When an installation already uses ZPL as a standard language & needs to maintain a consistent language for all thermal printers. • When certain printer functions . are not available in CPCL or EPL, such as: (ZBI, Datamatrix, Code 11, Micro PDF) • When replacing a PA/PT 40x, or another Zebra printer using ZPL, with a Zebra mobile printer
EPL (emulation available on QL, Encore, or Cameo series)	Zebra Desktops, R402™ (RFID printer), TR 220™, PS 21xx™ Series	<ul style="list-style-type: none"> • When an installation already uses EPL- the most commonly used Zebra language- as a standard language and needs to maintain a consistent language for all thermal printers. • If you are replacing Eltron Transport or Xport mobile printers, a Zebra mobile with an EPL emulation will ease the transition.

GETTING PRINTER INFORMATION

The printer can produce a report containing information about the application resident in printer memory. A report similar to the example printouts shown on the following pages can be obtained from your printer by doing the following:

1. Turn the printer OFF.
2. While holding the FEED key down, turn the printer ON.
3. When printing begins, release the FEED key.

The printer prints a line of interlocking “x” characters and then produces two reports. The first report indicates the printer model, ROM version, serial number, baud rate, etc.

The second report contains application information. The last digits in the application number indicate the software version.(e.g. “Software: HTLK**40**d” indicates a software version of 40.) If no second report appears, there is no application loaded.

The Wireless Communications report will appear if a Short Range Radio (SRRF), infrared (IrDA) or wireless LAN (RF LAN) option has been installed in the printer. If no wireless options are installed, the Wireless Communications Section will consist of a blank line.

The RF LAN Information section will only appear on Network Printers (units equipped with a WLAN card). Network printers are covered in detail in Section 12 of this manual.

The Label section shown in the second report reports the maximum size label that can be printed, based on a printer resolution of 203 dots/inch (8 dots/mm).

In the example, the Label Height is 2224 dots, which means for a label width of 576 dots (2.8 inches or 72 mm), you can print labels up to 10.9 inches (278 mm) long. Reducing the label width results in a corresponding increase in the maximum label length.

GETTING PRINTER INFORMATION EXAMPLE

Print Head Test

Zebra Encore3 V79.15 11/12/00
CHK: FFFF XSEC00-10-0042
HTE27915 /18
Testing Memory...
Memory tested and OK
Baud Rate: 19200 BPS
In-activity Timeout: 0 Secs
Low battery Shut-down: 168

End of report.

End of First Report

Zebra Encore3 V79/00 11/29/00
Serial Number:

XSEC00-10-0042

Unit Serial Number

Program:
Firmware:HTE27915 /18
Chksum:116B
Software:HTLAN28M
Chksum:A7EB
Ver:L4.R79.15.U126.B15.T19.A00

Application Number

Cable Communications:
19200 BPS, N,8,1
Handshake:Xon-Xoff/har

Report appears only on units with wireless options installed. (see RF LAN section below and next page)

Wireless Communications

RF LAN INFORMATION:
Release: 3.23
Date: 11/21/2000
ipAdr = 10.14.2.204
fwVersion = S4.40 000720
swVersion = Version 4.40
MAC addr = 00:a0:f8:8e:35:05
associated = YES
Device ID = XSEC00-10-0042
subnet = 255.255.255.0
protocol = LPD
powermode = SAVE
essID = ZebraNet
DHCP = OFF
DHCP_SAVE = OFF

Units with no wireless options will print an empty line and resume the report.

RF LAN Section (Network Printers only) Refer to Section 12.

10.14.2.204

Second report continues on P1-5

GETTING PRINTER INFORMATION EXAMPLE, CONT.

Wireless Communications Section with Short Range Radio (SRRF) Wireless Option Installed

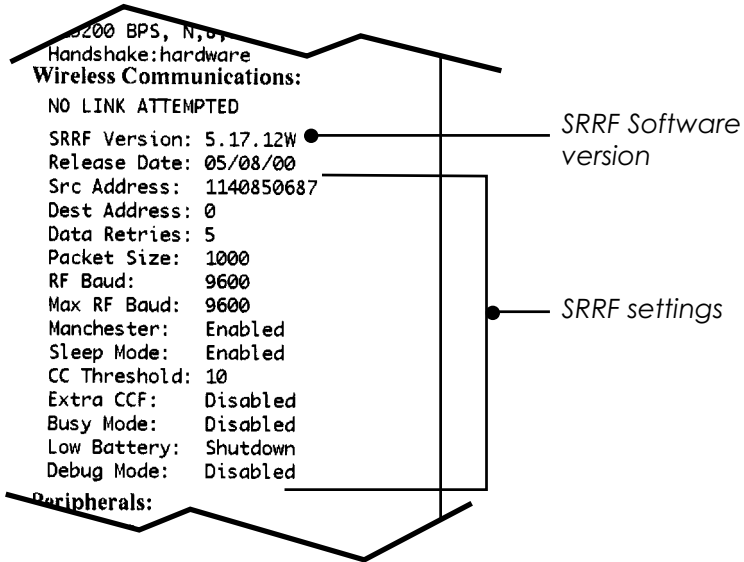

Wireless Communications Section with IR Wireless Option Installed

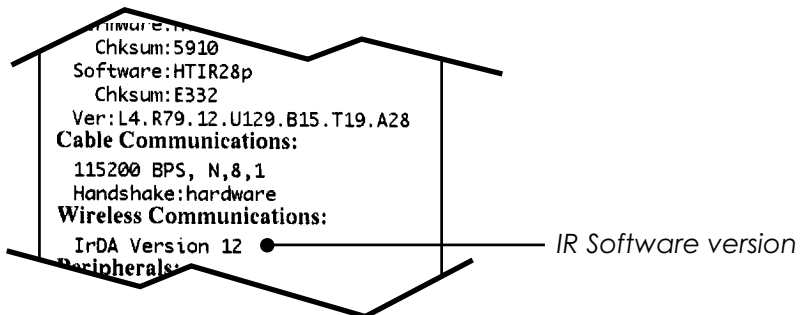

GETTING PRINTER INFORMATION EXAMPLE, CONT.

Continuation of Second Report

Peripherals:

Power Management:

In-activity Timeout:0 Secs
Low-battery Timeout:60 Secs
Remote(DTR) pwr-off:Disabled
Voltage :184
Low-bat Warning :178
Low-bat Shut-down :168

Memory:

Flash :1048575 Bytes ● *Flash Memory Size*

RAM : 262143 Bytes

Label:

Width :576 dots, 72 mm
Height:2224 dots, 278 mm ● *Maximum Label Size Refer to P1-7*

Sensors: (Adj)

Pres[DAC: 0,Thr:120,Cur:254]
Label Removed
Gap [DAC:215,Thr: 30,Cur:120]
Bar [DAC:111,Thr: 70,Cur: 11]
Temperature :179
Voltage :184

Resident Fonts:

Font	Sizes	Chars
0	0- 6	20-FF
1	0	20-80
2	0- 1	20-59
4	0- 7	20-FF
5	0- 3	20-FF
6	0	20-44
7	0- 1	20-FF
17(FTI_9_18.CPF)	0	● <i>Resident Fonts</i>

Pre-scaled or Scalable Fonts (if any) loaded in Memory

File Directory:

File	Size
IN001 .DMP	47
IN003 .DMP	486
IN002 .DMP	2
IN004 .DMP	771
FTI_9_18.CPF	1583

● *Files Loaded in Printer Memory (will include Pre-scaled or Scalable Fonts)*

808000 Bytes Free ● *Amount of Memory Available*

Command Language:

CCL Key '!' [21]

End of report.

Press FEED key to ● *Instructions on entering Communications Diagnostics (Dump) Mode. Refer to P1-6*

enter DUMP mode.

Dump mode not entered.

COMMUNICATIONS DIAGNOSTICS MODE

To aid the user in diagnosing communications problems, the printer features a Communications Diagnostics Mode (Dump Mode). In the dump mode, the printer will print the ASCII hex codes of the data sent to it, and their text representation (or the period '.', if not a printable character). As a test of the printer the "ALL CHR.S.LBL" file on the MPU disk may be sent.

To enter Communications Diagnostics Mode:

1. Turn the printer OFF.
2. Hold FEED key down.
3. Turn the printer ON.
4. Release FEED key when printer starts printing the diagnostics.
5. At the end of 2nd diagnostics report, the printer will print: "Press FEED key to enter DUMP mode".
6. Now press the FEED key. The printer will print: "Entering DUMP mode".

Note: If the FEED key is not pressed within 3 seconds, the printer will print "DUMP mode not entered" and will resume normal operation.

7. At this point, the printer is in DUMP mode and will print the ASCII hex codes of the data sent to it, and their text representation (or "." if not a printable character).

Additionally, a file with a ".dmp" extension containing the ASCII information will be created and stored in the printer's memory. It can be viewed, "cloned" or deleted using the Label Vista application. (Refer to pg. P1-8 and the Label Vista documentation for more information.)

To cancel Communications Diagnostics Mode:

1. Turn the printer OFF.
2. Wait 5 seconds.
3. Turn the printer ON.

LABEL COORDINATE SYSTEM

The x and y coordinates are expressed here in terms of dots. Coordinates in () are for 200 dot per inch printers. On 200 d.p.i. printers, 8 dots (either horizontally or vertically) equal 1 millimeter and 203 dots equate approximately to 1 inch.

Coordinates in [] are for 300 dot per inch printers. On 300 d.p.i. printers 12 dots equal 1 millimeter, and 305 dots equate approximately to 1 inch.

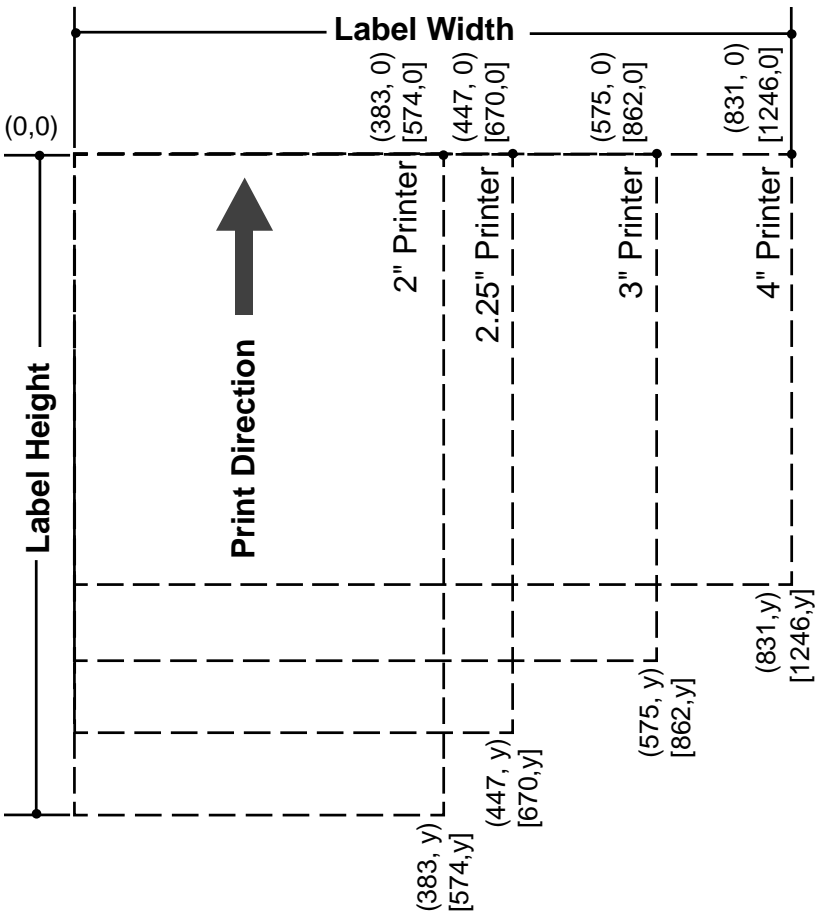

Notes:

1. Coordinates refer to the actual printing area of the printers.
2. "y" = the available label height which can vary with the resident application. (See Getting Printer Information, Page P1-3.)

LABEL VISTA™

Label Vista is a stand-alone program running in Windows™95/NT that allows users with little or no programming background to design labels which can be printed on certain model Zebra portable printers. It combines an intuitive graphically based user environment with powerful, but easily mastered, editing tools.

Label Vista allows the creation of printable, fixed-size (pre-scaled) fonts derived from an included library of TrueType™ fonts, which greatly enhances the versatility of this program.

In addition, Label Vista allows the easy creation of format files which can remain resident in the printer and be merged with variable data files sent from the host. This provides a very efficient method of printing labels that have a mixture of data fields that change from label to label and elements that remain constant. Refer to Section 8 of this Manual for more information on format files.

Label Vista also provides a powerful set of diagnostics tools. It is recommended that the Label Vista documentation package be consulted for a more detailed description of the printer diagnostics available in this program.

Label Vista utilizes a subset of the full Mobile Printing Systems Programming Language described in this manual. Files created in Label Vista are fully compatible with any other label files created using the complete set of Mobile Printer commands.

Label Vista requires an IBM compatible personal computer, running Windows 95 or later. A PC with the minimum configuration to run Windows 95 will have sufficient memory to run Label Vista.

Note: Label Vista has proven to be compatible with Windows XP in informal testing, however, compatibility problems with certain unusual combinations of hardware and software may arise.

PRINTER COMMANDS

A label file always begins with the “!” character followed by an “x” offset parameter, “x” and “y” axis resolutions, a label length and finally a quantity of labels to print. The line containing these parameters is referred to as the Command Start Line.

A label file always begins with the Command Start Line and ends with the “PRINT” command. The commands that build specific labels are placed between these two commands.

A space character is used to delimit each field in a command line.

Note: Every line in the command session must be terminated with both carriage-return and line-feed characters. All Printer Commands must be in uppercase characters ONLY.

PRINTER Commands

Format:

`<!/ > {offset} <200> <200> {height} {qty}`

where:

`<!/ >`: Use '!' to begin a control session.

`{offset}`: The horizontal offset for the entire label. This value causes all fields to be offset horizontally by the specified number of UNITS.

`<200>`: Horizontal resolution (in dots-per-inch).

`<200>`: Vertical resolution (in dots-per-inch).

`{height}`: The maximum height of the label. The maximum label height is calculated by measuring from the bottom of the first black bar (or label gap) to the top of the next black bar (or label gap). Then 1/16" [1.5mm] is subtracted from this distance to obtain the maximum height. (In dots: subtract 12 dots on 203 d.p.i printers; 18 dots on 306 d.p.i. printers)

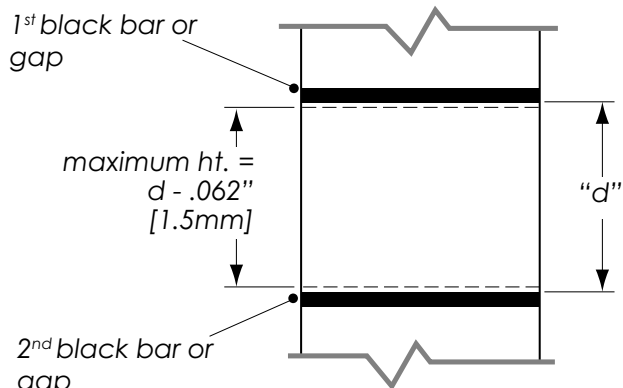

`{qty}`: Quantity of labels to be printed.
Maximum = 1024.

PRINTER Command Example

Input (HELLO.LBL):

```
! 0 200 200 210 1
TEXT 4 0 30 40 Hello World
FORM
PRINT
```

Output:

Hello World

PRINT Command

The PRINT command terminates and prints the file. This must always be the last command (except when in Line Print Mode). Upon execution of the PRINT command, the printer will exit from a control session. Be sure to terminate this and all commands with both carriage-return and line-feed characters.

Format:

{command}

where:

{command}: PRINT

FORM Command

The FORM command instructs the printer to feed to top of form after printing.

Format:

{command}

where:

{command}: FORM

In the following example, the printer will execute a form feed after the label is printed. See the SETFF (set form feed) command in the section on designing receipts and lists for information on setting printer behavior when the FORM command is executed.

```
Input: FORM.LBL  
  
! 0 200 200 3 1  
IN-CENTIMETERS  
CENTER  
TEXT 4 1 0 .5 Form Command  
FORM  
PRINT
```

JOURNAL Command

By default, the printer will check for correct media alignment if it encounters the eye-sense mark (black horizontal bars on back of media) during a print cycle (LABEL mode). If necessary, the JOURNAL command can be used to disable this automatic correction feature. The user's program is responsible for checking and assuring presence of paper in JOURNAL mode. Please refer to the status inquiry command for details on checking for out-of-paper condition.

Format:

{command}

where:

{command}: JOURNAL

UNITS Commands

The units commands are used to specify a measurement system for all subsequent command fields in a control session. Coordinates, widths, and heights for all control commands can be entered with precision to four decimal places. By placing a units command immediately after the first line in a control session, the specified measurement system will also apply to the offset and height fields. The printer measurement system will default to dots until a units command is issued.

Format:

{command}

where:

{command}: Choose from the following:

IN-INCHES Measurement in inches.

IN-CENTIMETERS Measurement in centimeters.

IN-MILLIMETERS Measurement in millimeters.

IN-DOTS Measurement in dots.

UNITS Examples

Input 1 (UNITS1.LBL):

```
! 0.3937 200 200 1 1
IN-INCHES
T 4 0 0 0 1 cm = 0.3937"
IN-DOTS
T 4 0 0 48 1 mm = 8 dots
B 128 1 1 48 16 112 UNITS
T 4 0 48 160 UNITS
FORM
PRINT
```

Output 1:

1 cm = 0.3937"
1 mm = 8 dots



Input 2 (UNITS2.LBL):

```
! 0 200 200 2.54 1
IN-CENTIMETERS
T 4 0 1 0 1" = 2.54 cm
IN-MILLIMETERS
T 4 0 0 6 203 dots = 25.4 mm
B 128 0.125 1 6 12 14 UNITS
T 4 0 16 20 UNITS
FORM
PRINT
```

Output 2:

1" = 2.54 cm
203 dots = 25.4 mm



USING COMMENTS

Comments can be added between the first line of a command session and the “PRINT” command.

A comment is placed in the file by starting a line with the ';' character in the first column. Any remaining text to the end of the line will be ignored. Comments are illegal between the CONCAT and ENDCONCAT commands.

COMMENTS Example

Input (COMMENT.LBL):

```
! 0 200 200 25 1
```

```
IN-MILLIMETERS
```

```
JOURNAL
```

```
; Center justify text
```

```
CENTER
```

```
; Print the words 'A COMMENT'
```

```
TEXT 5 1 0 5 A COMMENT
```

```
; Print the label and go to top of next form
```

```
FORM
```

```
PRINT
```

Output:

A COMMENT

TEXT

RESIDENT FONT SAMPLES

Font#: Size:
0 0

Aa Bb Cc Dd Ee Ff Gg Hh Ii Jj Kk Ll Mm Nn Oo
\$01.23456789¢ \$0123456789 \$0123456789 \$0123

Font#: Size:
0 5

Aa Bb Cc Dd Ee Ff Gg
\$01.23456789¢ \$0123

Font#: Size:
0 1

Aa Bb Cc Dd Ee Ff Gg
\$01.23456789¢ \$0123

Font#: Size:
0 6

Aa Bb Cc Dd
\$01.2345678¢

Font#: Size:
0 2

Aa Bb Cc Dd Ee Ff Gg Hh Ii Jj Kk Ll Mm Nn Oo
\$01.23456789¢ \$0123456789 \$0123456789 \$0123

Font#: Size:
1 0

Aa Bb Cc Dd Ee Ff Gg
~~\$01.23456789¢~~ \$0123

Font#: Size:
0 3

Aa Bb Cc Dd Ee Ff Gg
\$01.23456789¢ \$0123

Font#: Size:
2 0

A C D
~~\$01.23456789~~

Font#: Size:
0 4

Aa Bb Cc Dd
\$01.2345678¢

Font#: Size:
2 1

A C D
\$01.23456789

RESIDENT FONT SAMPLES (continued)

Font#: Size:
4 0

Aa Bb Cc Dd Ee Ff
\$01.23456789¢

Font#: Size:
4 1

Aa Bb Cc \$123

Font#: Size:
4 2

\$120.34

Font#: Size:
4 3

\$120.34

Font#: Size:
4 4

\$120.34

Font#: Size:
4 5

\$120.34

Font#: Size:
4 6

\$120.34

Font#: Size:
4 7

\$120.34

RESIDENT FONT SAMPLES (continued)

Font#: Size:

5 0

Aa Bb Cc Dd Ee Ff Gg Hh Ii Jj

\$01.23456789¢ \$01.234567890

Font#: Size:

6 0

ı ı' ıı' ııı'

0 1 2 3 4 5 6 7 8 9

Font#: Size:

5 1

Aa Bb Cc Dd Ee Ff Gg Hh Ii Jj

\$01.23456789¢ \$01.234567890

Font#: Size:

7 0

Aa Bb Cc Dd Ee Ff Gg Hh Ii Jj

\$01.23456789¢ \$01.234567890

Font#: Size:

5 2

Aa Bb Cc Dd Ee Ff

\$01.23456789¢

Font#: Size:

7 1

Aa Bb Cc Dd Ee Ff Gg Hh Ii Jj

\$01.23456789¢ \$01.234567890

Font#: Size:

5 3

Aa Bb Cc \$1.23 10¢

TEXT Commands

The TEXT command is used to place text on a label. This command and its variants control the specific font number and size used, the location of the text on the label, and the orientation of this text. Standard resident fonts can be rotated to 90° increments as shown in the example.

Format:

{command} {font} {size} {x} {y} {data}

where:

<i>{command}</i> :	Choose from the following:
TEXT (or T)	Prints text horizontally.
VTEXT (or VT)	Prints text (vertically) rotated 90 degrees counterclockwise.
TEXT90 (or T90)	(Same as VTEXT above.)
TEXT180 (or T180)	Prints text (upside down) rotated 180 degrees counterclockwise.
TEXT270 (or T270)	Prints text (vertically) rotated 270 degrees counterclockwise.
<i>{font}</i> :	Name/number of the font.
<i>{size}</i> :	Size identifier for the font.
<i>{x}</i> :	Horizontal starting position.
<i>{y}</i> :	Vertical starting position.
<i>{data}</i> :	The text to be printed.

TEXT Example

Input (TEXT.LBL):

```
! 0 200 200 210 1
TEXT 4 0 200 100 TEXT
TEXT90 4 0 200 100 T90
TEXT180 4 0 200 100 T180
TEXT270 4 0 200 100 T270
FORM
PRINT
```

Output:

```
08111T90
180T180
07270T270
TEXT
```

USING FONT GROUPS

FONT-GROUP (FG) Command

The FG command gives a user the ability to group up to 10 pre-scaled font files into a single group. A user can later specify the font group in a TEXT command. If a font group is used in a text command, the printer will use the *largest* font specified in the font group that will produce the required text data and still remain within the available width of the label for the text. When specified in the TEXT command, the {font} parameter is specified as FG, and the {size} parameter is specified as the {fg}. Note that a user can also specify an FG command within a CONCAT/ENCONCAT command.

Format:

{command} {fg fn fs} [fn fs] ...

where:

{command}: FG

{fg}: Font group number. Up to 10 font groups can be specified. Valid font groups range from 0 to 9.

{fn}: Name/number of the font.

{fs}: Size identifier for the font.

NOTE: Up to 10 font number/font size pairs can be assigned to a font group.

FG Example

In the example, the descriptions will be printed with the largest font in the specified font group that is capable of fitting the requested text in a 250 dot label field.

Input (FG.LBL):

```
! 0 200 200 250 1
; Specify fonts 0-0, 7-0, 5-0, 4-0 as members
; of font group 3.
FG 3 0 0 7 0 5 0 4 0
VT FG 3 10 250 Ketchup
VT FG 3 70 250 Fancy Ketchup
VT FG 3 120 250 Extra Fancy Ketchup
VT FG 3 180 250 Large Size Extra Fancy Ketchup
FORM
PRINT
```

Output:

Ketchup
Fancy Ketchup
Extra Fancy Ketchup
Large Size Extra Fancy Ketchup

TEXT CONCATENATION COMMANDS

Text concatenation allows you to assign different character styles to strings, printing them with uniform spacing on the same text line. This command can be used in combination with scalable fonts. See Scalable Concatenation Commands

Format:

```
{command} {x} {y}  
{font} {size} {offset} {data}  
    "      "      "      "  
{font} {size} {offset} {data}  
<ENDCONCAT>
```

where:

{command}: Choose from the following:

CONCAT	Horizontal concatenation.
VCONCAT	Vertical concatenation.

{x}: Horizontal starting position.

{y}: Vertical starting position.

{font}: Name/number of the font.

{size}: Size identifier for the font.

{offset}: Unit-value to offset text from the starting position. Used to align individual text strings or create superscript/subscript characters.

{data}: Text to be printed.

<ENDCONCAT>: Terminates concatenation.

TEXT CONCATENATION Example

Input (CONCAT.LBL):

```
! 0 200 200 210 1
CONCAT 75 75
4 2 5 $
4 3 0 12
4 2 5 34
ENDCONCAT
FORM
PRINT
```

Output:

\$1234

MULTILINE (ML) Commands

MULTILINE (ML) allows you to print multiple lines of text using the same font and line-height.

Format:

```
{command} {height}  
{text} {font} {size} {x} {y}  
{data}  
"  
{data}  
<ENDMULTILINE>
```

where:

{command}: Choose from the following:

MULTILINE Prints multiple lines of text.
(or ML)

{height}: Unit-height for each line of text.

{text}: Text command (TEXT, VTEXT, etc.).

{font}: Name/number of the font.

{size}: Size identifier for the font.

{x}: Horizontal starting position.

{y}: Vertical starting position.

{data}: Text to be printed.

<ENDMULTILINE>: Terminates MULTILINE.
(or ENDML)

MULTILINE Example

Input (MULTIL.LBL):

```
! 0 200 200 210 1
ML 47
TEXT 4 0 10 20
1st line of text
2nd line of text
:
Nth line of text
ENDML
FORM
PRINT
```

Output:

```
1st line of text
2nd line of text
:
Nth line of text
```

COUNT Command

The COUNT command is used for printing multiple labels where a numeric text field or numeric data encoded in a bar code is to be incremented or decremented for each label. The TEXT/BARCODE command string must contain this numeric data as the last characters of the string. The numeric data portion can be up to 20 characters, and can be preceded by the '-' sign. Incrementing or decrementing the numeric data thru '0' is not allowed. Leading zeros will be retained. Up to 3 COUNT commands can be used in a label file.

The numeric data incremented/decremented is contained in the TEXT or BARCODE command that immediately preceded the COUNT command.

Format:

{command} {numeric value}

where:

{command}: COUNT

{numeric value}: Any integer value up to 20 characters. The value can be preceded by a '-' sign if decrementing of the TEXT/BARCODE value is desired. Leading zeros will be retained in the output.

COUNT Example

Input (COUNT.LBL):

```
! 0 200 200 210 3
; Print 3 labels
CENTER
TEXT 4 0 0 50 TESTING 001
COUNT 1
TEXT 7 0 0 100 Barcode Value is 123456789
COUNT -10
BARCODE 128 1 1 50 0 130 123456789
COUNT -10
FORM
PRINT
```

Output:



SETMAG Command

The SETMAG command magnifies a resident font to the magnification factor specified.

Format:

{command} {w} {h}

where:

{command}: SETMAG

{w}: Width magnification of the font.
Valid magnifications are 1 thru 16.

{h}: Height magnification of the font.
Valid magnifications are 1 thru 16.

NOTE: The SETMAG command stays in effect after printing a label. This means that the next label printed will use the most recently set SETMAG values. To cancel any SETMAG values and allow the printer to use its default font sizes, use the SETMAG command with magnifications of 0,0.

SETMAG Example

Input (SETMAG.LBL):

```
! 0 200 200 210 1
CENTER
SETMAG 1 1
TEXT 0 0 0 10 Font 0-0 at SETMAG 1 1
SETMAG 1 2
TEXT 0 0 0 40 Font 0-0 at SETMAG 1 2
SETMAG 2 1
TEXT 0 0 0 80 Font 0-0 at SETMAG 2 1
SETMAG 2 2
TEXT 0 0 0 110 Font 0-0 at SETMAG 2 2
SETMAG 2 4
TEXT 0 0 0 145 Font 0-0 at SETMAG 2 4
; Restore default font sizes
SETMAG 0 0
FORM
PRINT
```

Output:

```
Font 0-0 at SETMAG 1 1
Font 0-0 at SETMAG 1 2
Font 0-0 at SETMAG 2 1
Font 0-0 at SETMAG 2 2
Font 0-0 at SETMAG 2 4
```

SCALABLE TEXT

Scalable text allows a user to print text at any point size. Point size can be specified for both the X and Y directions to produce characters that are "stretched" in either their width or height. Point sizes specified and text produced will print at 72 points equating to one inch (25.4mm).

The printer can contain scalable font files as part of the application, or scalable font files can be downloaded to the printer using one of the utilities on the supplied disk. A scalable text file must be present in your printer's memory in order to use scalable text features.

SCALE-TEXT Commands

The SCALE-TEXT commands allow the user to specify the point size of *both* the width and height of the font.

Format:

{command} {name} {width} {height} {x} {y} {data}

where:

{command}: Choose from the following:

SCALE-TEXT: Prints scaled text horizontally.
(or ST)

VSCALE-TEXT: Prints scaled text vertically.
(or VST)

{name}: Font name.

{width}: Font width (point size).

{height}: Font height (point size).

{x}: Horizontal starting position.

{y}: Vertical starting position.

{data}: Text to be printed.

SCALE-TEXT Example

Input (SCALE.LBL):

```
! 0 200 200 300 1
CENTER
; Print using x and y scales of 10 points
SCALE-TEXT PLL_LAT.CSF 10 10 0 10 10 POINT FONT
; Print using x scale of 20 points and y scale
; of 10 points
SCALE-TEXT PLL_LAT.CSF 20 10 0 80 WIDER FONT
; Print using x scale of 10 points and y scale
; of 20 points
SCALE-TEXT PLL_LAT.CSF 10 20 0 150 TALLER FONT
FORM
PRINT
```

Output:

10 POINT FONT

WIDER FONT

TALLER FONT

SCALE-TO-FIT Commands

The SCALE-TO-FIT commands automatically calculate the scale in order to fit text inside a window.

Format:

{command} {name} {width} {height} {x} {y} {data}

where:

{command}: Choose from the following:

SCALE-TO-FIT: Prints scaled text horizontally.
(or STF)

VSCALE-TO-FIT: Prints scaled text vertically.
(or VSTF)

{name}: Font name.

{width}: Unit-width of the window.

{height}: Unit-height of the window.

{x}: Horizontal starting position.

{y}: Vertical starting position.

{data}: Text to be printed.

SCALE-TO-FIT Example

Input (STF.LBL):

```
! 0 200 200 100 1
IN-MILLIMETERS
CENTER
; Fit a text string into an area 40mm wide by 10mm
; high
SCALE-TO-FIT PLL_LAT.CSF 40 10 0 10 SALE
; Fit a longer text string into the same 40mm wide
; by 10mm high area
SCALE-TO-FIT PLL_LAT.CSF 40 10 0 20 SALE PRICE
; Fit "SALE" text into a 40mm wide by 20mm high
; area
SCALE-TO-FIT PLL_LAT.CSF 40 20 0 30 SALE
FORM
PRINT
```

Output:

SALE
SALE PRICE
SALE

SCALABLE CONCATENATION Commands

Scalable concatenation allows you to assign different character styles to strings, printing them with uniform spacing on the same text line. Both scalable and bitmap text can be combined between a CONCAT/ENCONCAT command. See also Text Concatenation Commands

Format:

```
{command} {x} {y}  
<ST> {name} {width} {height} {offset} {data}  
  "      "      "      "      "      "  
<ST> {name} {width} {height} {offset} {data}  
<ENDCONCAT>
```

where:

{command}: Choose from the following:

CONCAT Horizontal concatenation.
VCONCAT Vertical concatenation.

{x}: Horizontal starting position.

{y}: Vertical starting position.

{name}: Font name.

{width}: Font width point size.

{height}: Font height point size.

{offset}: Unit-value to offset text from the starting position. Used to align individual text strings or create superscript/subscript characters.

{data}: Text to be printed.

<*ENDCONCAT*>: Terminates concatenation.

SCALABLE CONCATENATION Example

Input (STC.LBL):

```
! 0 200 200 210 1
CENTER
; Concatenate 3 scalable font strings and 1
; Resident font string
CONCAT 0 20
4 1 0 2/
ST PLL_LAT.CSF 20 20 15 $
ST PLL_LAT.CSF 40 40 0 22
ST PLL_LAT.CSF 20 20 0 99
ENDCONCAT
FORM
PRINT
```

Output:

2/\$22⁹⁹

ROTATE Commands

ROTATE commands are used to rotate all subsequent scalable text fields at a specified angle. Rotation direction is counter-clockwise about the center point of the text. This rotation remains in effect until another ROTATE command is issued. Default angle is zero degrees.

Format:

{command} {angle}

where:

{command}: Choose from the following:

ROTATE
(or R) Rotates scalable fonts.

{angle}: Degree of rotation (ccw).

ROTATE Example

Input (ROTATE.LBL):

```
! 0 200 200 440 1
CENTER
TEXT 4 1 0 50 Rotate Strings
ROTATE 45
CONCAT 50 300
ST PLL_LAT.CSF 20 20 20 $
ST PLL_LAT.CSF 40 40 0 22
ST PLL_LAT.CSF 20 20 0 99
ENDCONCAT
FORM
PRINT
```

Output:

Rotate Strings

\$22⁹⁹

LINEAR BAR CODES

Bar codes allow easy implementation of automated identification, cataloging and processing of almost any object. They have been successfully used on items ranging in size from boxcars to bumblebees.

This overview of barcode symbologies will help when programming Zebra mobile printers and/or designing labels with Label Vista software.

If you plan to create software using these bar codes, we recommend ordering the uniform symbology specification from AIM or the UCC to determine the uses and limitations pertaining to that type of barcode. The information in this document is in no way complete.

The following discussions contain basic information and some suggested applications for each type of bar code. The quick reference table in Appendix E lists specific data for each bar code in one location. All the information on ideal widths and ratios comes directly from the uniform symbology specification. Please note that all measurements contained in this document are in printer dots. On 200 dot per inch (dpi) printers, one dot is equal to 0.005" or 0.13 millimeters, on 300 dpi printers one dot is equal to 0.003" or 0.07 millimeters.

RESIDENT LINEAR BAR CODE SAMPLES

UPC-A



01234567890

UPC-E



0123450

EAN-13



0012345678905

EAN-8



40153476

UPC/EAN Plus 2
Extender



12

UPC/EAN Plus 5
Extender



12345

CODE 39



CODE 39

CODE 93



C93/Ext.

I 2 OF 5



123456

CODE 128



CODE 128

UCC-128



0123456789

CODABAR



a12345a

PLESSY MS110



12345678

POSTNET



012345678

UPC AND EAN/JAN BAR CODES

UPC and EAN/JAN bar codes are typically used for marking products with a unique code used to look up prices and to track inventories of goods sold. They are also used for store coupons, periodicals, and paperback books. UPC and EAN/JAN bar codes are generally rectangular, contain a fixed amount of data, and in most cases are accompanied by human readable text printed below them. For best results, this text should be an OCR-A (resident font 2), a sans serif font (resident font 7) or an OCR-B font.

The first number in the UPC/EAN bar code is the number system character. The specification lists use of characters 0 through 9 as follows.

- 0 Regular UPC codes (UPC-A and UPC-E)
- 1 Reserved
- 2 Random weight items, like store packaged meat. (UPC-A only)
- 3 National Drug Code and National Health Related Items Code in current 10-digit code length (UPC-A only)*
- 4 In-store marking of non food items without code format restriction and with check digit protection (UPC-A only)
- 5 Coupons (UPC-A only)
- 6 Regular UPC codes (UPC-A only)
- 7 Regular UPC codes (UPC-A only)
- 8 Reserved
- 9 Reserved

* Number system 3 has the following note in the specification. "...the symbol is not affected by the various internal structures possible with the NDC or HRI codes." The users should determine what effect this statement may have on their program. It will not change how bar codes are printed.

The checksum is the last number in the bar code and can be used to make certain that the bar code is decoded properly. This digit is *automatically* calculated by the printer. The UPC barcode specification has the full instructions for calculating this checksum. The methodology is as follows:

For this example, the bar code will be 01234567890.

Step 1: Starting at the left, including the number system character, add up all the numbers in the ODD positions. ($0 + 2 + 4 + 6 + 8 + 0 = 20$)

Step 2: Multiply this sum by 3. ($20 \times 3 = 60$)

Step 3: Starting at the left again, add up all the numbers in the EVEN positions. ($1 + 3 + 5 + 7 + 9 = 25$).

Step 4: Add the results from step 2 and step 3. ($60 + 25 = 85$)

Step 5: The checksum is the smallest number when added to step 4 will equal a multiple of ten. In our example: $85 + 5 = 90$, which is a multiple of 10. Therefore, the check digit should be 5. It is called a modulo checksum because you take the modulo, or remainder, of the sum. For the programmers, it is:

$10 - (85 \bmod 10) = \text{the checksum.}$

UPC-A and EAN13 bar codes can be created with and without a checksum supplied. If the programmer supplies a checksum digit, the printer will create the bar code with that check digit, *even if it is incorrect*. Most laser scanning devices will not be able to decode the bar code if the check digit is incorrect,

UPC-E bar codes, useful for small items like candy and gum, are created through the method of “zero suppression.” For example, if you were to encode 01000000567, the resulting bar code would be a compressed bar code

that only contains the data, the compression scheme, and the checksum without all the extra zeros. For our example, the bar code would decode to 1056707. Please refer to the UPC Symbol Specification Manual from the Uniform Code Council for more information on zero suppression.

UPC-E and EAN8 bar codes have a few restrictions. First, the number system character must be set to 0. Number systems 1 through 9 do not support UPC-E and EAN8 bar codes and may not be decoded by a laser scanning device. In case your application requires it, the number system may be set to something other than 0. Second, if the programmer supplies a checksum digit, the printer will create the bar code with that check digit, *even if it is incorrect*. If the check digit is incorrect, most laser scanning devices will not be able to decode the bar code. Therefore, the programmer may send six digits (no number system, no checksum), seven digits (number system, no checksum), or eight digits (number system and checksum) and create a bar code.

Plus 2 and plus 5 barcode extensions are only used for periodicals and paperback books. Specifically, the bar code specification states that the plus 2 extension should only be used for a periodical issue number. The plus 2 and plus 5 extensions do not contain any checksum according to the barcode specification.

To create an extended bar code, place a space between the data that should go into the UPC/EAN bar code and the data that should go into the extension. You can also use the PLUS2 and PLUS5 barcode types to create the extension separately. Remember to leave ample space (about 9 times the ratio) between the UPC/EAN bar code and the extension.

UPC/EAN SPECIFICATIONS

Barcode Symbology	Barcode Type	Input Length	Characters	Ideal Wide/Narrow Ratio	Ideal Narrow Dot Width	Checksum Calculation
UPC-A	UPCA	11 or 12 digits	0-9 only	2:1	2	mod 10
UPC-A plus 2	UPCA2	13 digits	0-9 only	2:1	2	mod 10 (UPC-A)
UPC-A plus 5	UPCA5	16 digits	0-9 only	2:1	2	mod 10 (UPC-A)
UPC-E	UPCE	6, 7 or 11 digits	0-9 only	2:1	2	mod 10
UPC-E plus 2	UPCE2	8 or 13 digits	0-9 only	2:1	2	mod 10 (UPC-E)
UPC-E plus 5	UPCE5	11 or 16 digits	0-9 only	2:1	2	mod 10 (UPC-E)
EAN/JAN-13	EAN13	12 or 13 digits	0-9 only	2:1	2	mod 10
EAN/JAN-13 plus 2	EAN132	14 digits	0-9 only	2:1	2	mod 10 (EAN13)
EAN/JAN-13 plus 5	EAN135	17 digits	0-9 only	2:1	2	mod 10 (EAN13)
EAN/JAN-8	EAN8	6, 7 or 8 digits	0-9 only	2:1	2	mod 10
EAN/JAN-8 plus 2	EAN82	9 digits	0-9 only	2:1	2	mod 10 (EAN8)
EAN/JAN-8 plus 5	EAN85	12 digits	0-9 only	2:1	2	mod 10 (EAN8)

CODE 39 OR CODE 3 OF 9 BAR CODES

The Code 39 bar code is used for many applications including inventories, hospital applications, or any other place where the code length may change between items being scanned (e.g. a bar code stating there were 420 pieces in one box and 20004 pieces in another box would have a different physical length). This bar code can use the characters 0 through 9, A through Z, '-' (dash), "." (period), space, "\$" (dollar sign), "/" (forward slash), "+" (plus) and "%" (percent). There is also a special character called "S/S" used as a start/ stop character. The F39 and F39C types allow the use of carriage return, line feed, and null characters.

The checksum for this bar code is located as the last (or least significant) digit of the decoded bar code. To **assure** data integrity in your application, use a bar code with a checksum. The printer will *automatically* supply

this digit if the user selects a 39C or a F39C bar code.

Check Character Numerical Value Table

Char	Value	Char	Value	Char	Value	Char	Value
0	0	C	12	O	24	-	36
1	1	D	13	P	25	.	37
2	2	E	14	Q	26	SPACE	38
3	3	F	15	R	27	\$	39
4	4	G	16	S	28	/	40
5	5	H	17	T	29	+	41
6	6	I	18	U	30	%	42
7	7	J	19	V	31	\$(full)	43*
8	8	K	20	W	32	% (full)	44*
9	9	L	21	X	33	/(full)	45*
A	10	M	22	Y	34	+(full)	46*
B	11	N	23	Z	35		

* Full represents F39 or F39C for Full ASCII

Refer to the full barcode symbology specification for complete information on checksum calculation. For a short example, take an example bar code with the data "CODE 39".

Step 1: Assign a value to each character per the Character Numerical Value Table above. C=12, O=24, D=13, E=14, space = 38, 3=3, 9=9.

Step 2: Add the values 12+24+13+14+38+3+9=113.

Step 3: Divide this number by 43. The remainder or modulo, 27, is the checksum.

Step 4: Referring to the table, 27 is the character R.

Therefore, the checksum in the bar code should be R. The final code reads "CODE 39R" when it is decoded.

CODE 39 (3 OF 9) SPECIFICATIONS

Barcode Symbology	Barcode Type	Input Length	Characters	Ideal	Ideal	Checksum Calculation
				Wide/Narrow Ratio	Narrow Dot Width	
Code 39	39	Variable	Refer text	2.5:1	2	none
	39C	Variable	Refer text	2.5:1	2	mod 43
	F39	Variable	Refer text	2.5:1	2	none
	F39C	Variable	Refer text	2.5:1	2	mod 43

CODE 93 OR CODE 9 OF 3 BAR CODES

The Code 93 bar code is used for applications that require heavy error checking capabilities. To accomplish this, the Code 93 bar code contains two separate error checking checksums that are automatically calculated and placed into the bar code. This bar code is used for inventories, hospital applications, or any other place where the length may change between items being scanned. (See Code 39 above.) This bar code type can use the entire ASCII 128 character set. It is useful for encoding data and phrases like "Code 93".

The two checksums in this bar code are located as the last and second to last characters in the decoded bar code. Code 93 has a complex checksum calculation. Please see the barcode symbology specification for information on how to create and decode this checksum. Please also note that the barcode symbology specification does not state any ideal values for the ratio and the width of the narrow bar.

CODE 93 SPECIFICATIONS

Barcode Symbology	Barcode Type	Input Length	Characters	Ideal Wide/Narrow Ratio	Ideal Narrow Dot Width	Checksum Calculation
Code 93	93	Variable	128 ASCII	1.5:1	1	two mod 47

INTERLEAVED 2 OF 5 BAR CODES

The Interleaved 2 of 5 (or ITF) Bar code is used for applications that have a fixed data length for all items scanned. A date, telephone number, or a SKU of fixed length would be a good application for this bar code. The symbology specification states that a ITF bar code may be partially decoded without any recognizable difference. Therefore, to prevent this problem, you must keep the length of data to a constant and perform an error checking routine on the decoding program to determine if the data is correct.

Only the digits 0-9 can be encoded, and there should

be an even number of digits in the data. If there is an odd number of digits, the printer will automatically insert a zero (0) at the beginning of the bar code.

There are two bar code varieties with a checksum: Interleaved 2 of 5 “with checksum” and German Post Code. German Post Code has fixed length – either 12 or 14 characters (including checksum).

Here is an example how to calculate modulo 10 checksum:

Step 1: To calculate the checksum, first ensure that you are starting with an odd number of digits in the data. If not, add a zero (0) to the beginning of the data.

Step 2: Multiply every other digit by 3, and add up the numbers. So, if your data was “43827” your calculation should be $(4 \times 3) + 3 + (8 \times 3) + 2 + (7 \times 3) = 62$.

Step 3: Divide this number by 10, resulting in 6 with a remainder of 2. Subtract the remainder from 10. In our example, $10 - 2 = 8$. The checksum is this final number, 8. Append this to the end of your data. Note that if the remainder was a zero, your checksum should be zero.

INTERLEAVED 2 OF 5 SPECIFICATIONS

Barcode Symbology	Barcode Type	Input Length	Characters	Ideal Wide/Narrow Ratio	Ideal Narrow Dot Width	Checksum Calculation
Interleaved 2 of 5	I2OF5	Varies	0-9 only	2.5:1	2	See text
Interleaved 2 of 5 with checksum	I2OF5C	Varies	0-9 only	2.5:1	2	See text
German Post Code	I2OF5G	11, 12, 13 or 14	0-9 only	2.5:1	2	mod 10, weights 4,9

CODE 128 AND THE UCC-128 SHIPPING STANDARD

Code 128 is used for applications that need to contain a large amount of data such as shipping applications, marking blood donations, and any other application that can vary in length between bar codes being scanned. The bar code also contains a checksum as the last char-

acter in the code which ensures that data remains intact.

Code 128 can use the entire ASCII 128 character set as well as other subsets available in the universal symbology specification. The three start and stop characters determine which character set to use. The checksum for this bar code is located immediately before the stop character. The barcode symbology specification contains all the information on calculating this checksum. For a short example, we desire to encode "BAR128" in a bar code. We will use "A" as our start and stop character in this example.

Step 1: The symbology specification assigns a numerical value for each character. Find the values of all the characters in the data.

Step 2: Add the value of the start character and all the data characters multiplied by its position in the bar code. For our example, the calculation would be $103 + (34 \times 1) + (32 \times 2) + (50 \times 3) + (17 \times 4) + (18 \times 5) + (24 \times 6) = 672$.

Step 3: Divide this number by 103. The remainder or modulo, 54, is the checksum. The character that assigned to 54 in the specification is "V". Our final code will look like "ABAR128V" where "A" is the start character, "BAR128" is the data, and "V" is the checksum.

The UCC-128 Shipping Standard is part of a document called *Application Standard for Shipping Container Codes* available from the Uniform Code Council. This 90-page guide contains the entire specification on marking any shipment sent anywhere in the United States. Seventeen pages are dedicated to the technical considerations of using, placing, and printing these bar codes. We highly recommend getting this information if your application involves shipping.

CODE 128/ UCC-128 SPECIFICATIONS

Barcode Symbology	Barcode Type	Input Length	Characters	Ideal	Ideal	Checksum Calculation
				Wide/Narrow Ratio	Narrow Dot Width	
Code 128 /A/B/C/Auto	128	Variable	Refer text	1.5:1	1	mod 103
UCC-128Std.	UCCEAN 16	Refer text	Refer text	3:1	3	mod 103

CODABAR

Codabar is ideal for applications that contain mostly numeric symbols that may vary in length from bar code to bar code. It can encode the digits from 0 to 9, the characters “-”(dash), “\$”(dollar sign), “:”(colon), “/”(forward slash), “.”(period), and “+”(plus) as well as start/stop characters A through D.

One optional checksum is automatically appended as the least significant digit in the barcode data directly before the stop character. The barcode symbology specification contains all the information on calculating the checksum. As a short example, our data will be “A37859B” where A and B are start/stop characters. The characters 0 through 9 are assigned the numerical values 0 through 9 respectively. “-” is 10, “\$” is 11, “:” is 12, “/” is 13, “.” is 14, “+” is 15, and start/stop characters A B C and D are 16, 17, 18, and 19 respectively.

Step 1: Add the numerical value of all the characters.

$$16 + 3 + 7 + 8 + 5 + 9 + 17 = 65.$$

Step 2: Divide this number by 16 and use the remainder, or modulo. In our example, this is 1

Step 3: Subtract the modulo from 16. This is the smallest number that can be added to the sum in step 1 to make a multiple of 16. (65 + 15 =80. 80 /16= 5)
Therefore, the check sum for our example is 15.

Step 4: The character that corresponds to 15 is “+” and is added in before the stop character. Our final bar code looks like “A37859+B”.

The barcode type NW7 is for reverse compatibility only. We do not recommend using this command for new systems. There is no difference between CODABAR and NW7.

CODABAR SPECIFICATIONS

Barcode Symbology	Barcode Type	Input Length	Characters	Ideal Wide/Narrow Ratio	Ideal Narrow Dot Width	Checksum Calculation
Codabar	CODABAR	Variable	0-9,A-D symbol	2.5:1	2	none
	CODABAR	Variable	0-9,A-D, 16 symbol	2.5:1	2	mod 16

MSI PLESSEY BAR CODES

The MSI Plessey bar code is a fixed length code that uses only numerical characters. It is primarily used for grocery applications. Three different types of encoding exist with different levels of data protection. Please see the bar code symbology specification for more information on how to calculate these checksums.

The barcode type “PLESSEY” is used for reverse compatibility only. We do not recommend using this command for new systems. The PLESSEY type will force a 2:1 ratio of the wide to narrow bar width.

MSI PLESSY SPECIFICATIONS

Barcode Symbology	Barcode Type	Input Length	Characters	Ideal Wide/Narrow Ratio	Ideal Narrow Dot Width	Checksum Calculation
MSI Plessey	MSI	13 digits max	0-9 only	2:1	2	none
	MSI10	13 digits max	0-9 only	2:1	2	mod 10
	MSI1010	13 digits max	0-9 only	2:1	2	two mod 10
	MSI1110	13 digits max	0-9 only	2:1	2	mod 11 mod 10

POSTNET AND FACING IDENTIFICATION MARKS

The US Postnet bar code is used only to help automate mail delivery. To comply with postal regulations, set the height of the bar code to 30 dots, the wide/narrow bar ratio at 3.5:1, and the width of the narrow bar to 3 dots on a 200 dpi printer. The data sent to the bar code can be 5, 9, or 11 digits long. For example, to send mail to 30 Plan Way, Warwick, RI 02886-1234, the data would be

5 digits- ZIP Code only: 02886

9 digits - ZIP + 4 Code: 028861234

11 digits - ZIP + 4 Code and last two digits in address:
02886123430

The Postnet bar code also contains an automatically calculated checksum as the last character in the decoded bar code. As a short example, our data will be "02881123430"

Step 1: Add the numerical value of all the characters.
 $0+2+8+8+1+1+2+3+4+3+0 = 32$.

Step 2: Divide this number by 10 and use the remainder, or modulo. In our example, this is 2

Step 3: Subtract the remainder (or modulo) from 10 to get the check sum. The check sum for our example would be 8 ($10 - 32 \text{ mod } 10$ for programmers).

A Facing Identification Mark (FIM) is the bar in the upper right corner of an envelope near the stamp. To comply with postal regulations, set the height of the bar code to 125 dots, the ratio to 1.5:1 dots, and the width of the narrow bar to 6 dots. There are three different characters you can send as data: A, B, and C.

FIM A: Courtesy Reply Mail with Postnet Bar code

FIM B: Business Reply Mail, Penalty Mail, or Franked

Mail without Postnet Bar code

FIM C: Business Reply Mail, Penalty Mail, or Franked Mail with Postnet Bar code.

For more information, please see Publication 25 from the USPS Postal Business Center. If you are making a label with an address, try using resident font 7 or font 4 for best results with the optical character recognition software used by the post office.

POSTNET AND FIM SPECIFICATIONS

Barcode Symbology	Barcode Type	Input Length	Characters	Ideal Wide/Narrow Ratio	Ideal Narrow Dot Width	Checksum Calculation
Postnet	POSTNET	5, 9, 11 digits	0-9 only	3.5:1	3	mod 10
Facing						
Ident Mark	FIM	A, B, or C only	A, B, or C	1.5:1	6	N/A

BAR CODE COMMANDS

The following commands are used for the creation and formatting of bar codes on labels. Insure that the bar code symbology chosen agrees with its intended use, and that it conforms to the guidelines in the previous section.

A Quick Reference Guide for the linear bar code symbologies discussed in this manual can be found in Appendix “E”.

Note that the “COUNT” command is also discussed in Section 3 of this manual.

BARCODE Command

The BARCODE command prints bar codes in both vertical and horizontal orientations at specified widths and heights.

Standard Bar Codes

Format:

{command} {type} {width} {ratio} {height} {x} {y} {data}

where:

{command}: Choose from the following:

BARCODE Prints bar code horizontally.
(or B)

VBARCODE Prints bar code vertically.
(or VB)

{type}: Choose from the following table:

<u>Symbology:</u>	<u>use:</u>
UPC-A	UPCA, UPCA2, UPCA5
UPC-E	UPCE, UPCE2, UPCE5
EAN/JAN-13	EAN13, EAN132, EAN135
EAN/JAN-8	EAN8, EAN82, EAN 85
Code 39	39, 39C, F39, F39C
Code 93/Ext. 93	93
Interleaved 2 of 5	I2OF5
Interleaved 2 of 5 with checksum	I2OF5C
German Post Code	I2OF5G
Code 128 (Auto)	128
UCC EAN 128	UCCEAN128
Codabar	CODABAR, CODABAR16
MSI/Plessey	MSI, MSI10, MSI1010, MSI1110
Postnet	POSTNET
FIM	FIM

{width}: Unit-width of the narrow bar.

{ratio}: Ratio of the wide bar to the narrow bar.
Refer to the table in Appendix “E” for appropriate settings.

0 = 1.5 : 1	20 = 2.0:1	26 = 2.6:1
1 = 2.0 : 1	21 = 2.1:1	27 = 2.7:1
2 = 2.5 : 1	22 = 2.2:1	28 = 2.8:1
3 = 3.0 : 1	23 = 2.3:1	29 = 2.9:1
4 = 3.5 : 1	24 = 2.4:1	30 = 3.0:1
	25 = 2.5:1	

Note: The ratios in the Appendix are suggested for best results, however any ratio can be assigned.

{height}: Unit-height of the bar code.

{x}: Horizontal starting position.

{y}: Vertical starting position.

{data}: Bar code data.

BAR CODE Example

Input (BARCODE.LBL):

```
! 0 200 200 210 1  
BARCODE 128 1 1 50 150 10 HORIZ.  
TEXT 7 0 210 60 HORIZ.  
VBARCODE 128 1 1 50 10 200 VERT.  
VTEXT 7 0 60 140 VERT.  
FORM  
PRINT
```

Output:



BARCODE-TEXT Command

The BARCODE-TEXT command is used to label bar codes with the same data used to create the bar code. The command eliminates the need to annotate the bar code using separate text commands. The text will be centered below the bar code.

Use BARCODE-TEXT OFF (or BT OFF) to disable.

Format:

{command} {font number} {font size} {offset}

where:

{command}: BARCODE-TEXT
 (or BT)

{font number}: The font number to use when
 annotating the bar code.

{font size}: The font size to use when annotat-
 ing the bar code.

{offset}: Unit distance to offset text away
 from the bar code.

BARCODE-TEXT Example

Input (BARTEXT.LBL):

```
! 0 200 200 400 1
JOURNAL
CENTER
; Annotate bar codes using font 7 size 0
; and offset 5 dots from the bar code.
BARCODE-TEXT 7 0 5
BARCODE 128 1 1 50 0 20 123456789
VBARCODE 128 1 1 50 40 400 112233445
BARCODE-TEXT OFF
FORM
PRINT
```

Output:



COUNT Command

The COUNT command is used for printing multiple labels where a numeric text field or numeric data encoded in a bar code is to be incremented or decremented for each label. The TEXT/BARCODE command string must contain this numeric data as the last characters of the string. The numeric data portion can be up to 20 characters, and can be preceded by the '-' sign. Counts of 9 → 0 will wrap to 9. Counts of 00 → 99 will wrap to 00. Leading zeros will be retained. Up to 3 COUNT commands can be used in a label file.

The numeric data incremented/decremented is contained in the TEXT or BARCODE command that immediately preceded the COUNT command.

Format:

{command} {numeric value}

where:

{command}: COUNT

{numeric value}: Any integer value up to 20 characters. The value can be preceded by a '-' sign if decrementing of the TEXT/BARCODE value is desired. Leading zeros will be retained in the output.

COUNT Example

Input (COUNT.LBL):

```
! 0 200 200 210 3
; Print 3 labels
CENTER
TEXT 4 0 0 50 TESTING 001
COUNT 1
TEXT 7 0 0 100 Barcode Value is 123456789
COUNT -10
BARCODE 128 1 1 50 0 130 123456789
COUNT -10
FORM
PRINT
```

Output:



TWO-DIMENSIONAL BAR CODES

Introduction

A two dimensional barcode can be regarded as a “portable database.” For example, if a package has a serial number encoded with a linear barcode, you could scan the serial number, look up the number in a computer system, and gather the information about that package. If the computer system was unavailable for any reason the information you were looking for would also be unavailable. A 2D barcode, however, can contain several different fields of information in them, essentially a database attached to a package.

The first 2D barcode was just an extension of a one-dimensional barcode. The user could stack several Code 39 barcodes on top of another. These types of codes are called “stacked symbology” or “multi-row codes”. Development of scanners capable of 2D scanning allowed use of more compact and useful symbologies like PDF417 from Symbol and MaxiCode from the United Parcel Service.

Zebra mobile printers have capabilities to print PDF417 and MaxiCode symbols. If your application requires the use of PDF417 or MaxiCode symbols, we highly recommend acquiring the universal symbol specification to assist your programming. The specifications include suggestions on how to structure your data in the code to make it easier to use.

Please note that you must load a special application before using PDF417 or MaxiCode on your Zebra mobile printer. The standard application loaded in your printer does not support the ability to print these barcodes. Contact the Help Desk for more information on how to load this application.

PDF417

The PDF417 barcode is a 2D barcode that can contain a very large amount of data in a small space. If you look at a PDF417 barcode carefully, it is actually a stack of smaller barcodes. The number and height of the stacks are controllable by the user. The barcode can contain the entire ASCII 255 set of characters, and has the capability to use different encoding schemes and different levels of security to correct errors. The largest amount of data that can be encoded is 2725 characters

MaxiCode

MaxiCode was originally designed by the United Parcel Service to help them automate package delivery and sort packages coming down a quick conveyor belt. It consists of a bulls eye to help the imaging system “target” the barcode and an array of hexagons to represent the data stored in the barcode. It can contain a maximum of 93 alphanumeric characters or 138 numeric characters, has two different error correction modes, seven different storage modes, the capability to use character sets other than ASCII, and the capability to “link” several MaxiCodes together. Since there are so many different modes, it is suggested that you contact AIM for the symbol specification. If you are developing software to be used with the UPS MaxiCode shipping system, contact UPS for information on how to order the information on the Maxicode shipping system.

TWO-DIMENSIONAL BAR CODE COMMANDS

The following commands are used for the creation and formatting of two-dimensional bar codes. Insure that the bar code symbology chosen agrees with its intended use. We recommend acquiring the specification for the desired code to supplement the discussions in this manual. Note that Codablock “A” and “F” are not fully supported in this release of the manual.

PDF417 (PORTABLE DATA FILE)

Format:

```
{command} {type} {x} {y} [XD n] [YD n] [C n] [S n]  
{data}  
<ENDPDF>
```

where:

{command}: Choose from the following:

BARCODE Prints bar code horizontally.
(or B)

VBARCODE Prints bar code vertically.
(or VB)

{type}: PDF-417

{x}: Horizontal starting position.

{y}: Vertical starting position.

[XD n]: Unit-width of the narrowest element.
Range is 1 to 32.
Default is 2.

[YD n]: Unit-height of the narrowest element.
Range is 1 to 32.
Default is 6.

[C n]: Number of columns to use. Data columns do not include start/stop characters and left/right indicators.
Range is 1 to 30.
Default is 3.

PDF 417 (PORTABLE DATA FILE) continued

(continued)

[S n]: Security level indicates maximum amount of errors to be detected and/or corrected.
Range is 0 to 8.
Default is 1.

{data}: Bar code data.

<ENDPDF>: Terminates PDF-417.

Note: The BARCODE-TEXT command does not work with the PDF-417 barcode type. Any desired human readable text must be entered separately with the TEXT command as in the example below.

PDF417 Example

Input (PDF.LBL):

```
! 0 200 200 210 1
B PDF-417 10 20 XD 3 YD 12 C 3 S 2
PDF Data
ABCDE12345
ENDPDF
T 4 0 10 120 PDF Data
T 4 0 10 170 ABCDE12345
FORM
PRINT
```

Output:



PDF Data
ABCDE12345

MAXICODE

Revised: Application Version 25 or higher

The Maxicode bar code now handles all the symbols defined by the United Parcel Service as well as the basic fields supported in the standard bar code. Maxicode supports all standard printable characters with automatic conversion of all lowercase letters in the secondary message to uppercase. This revision supports only Mode 2 bar codes.

Format:

```
{command} {type} {x} {y}
{tag} {options}
...
{tag} {options}
<ENDMAXICODE>
```

where:

{command}: BARCODE or B

Prints bar code.

{type}:

MAXICODE

{x}:

Horizontal starting position

{y}:

Vertical starting position

{tag}:

Tags not supplied will be filled with default values. Use only the tags that you require. Tags can be in any order.

<ENDMAXICODE> Final tag in Maxicode barcode.

Tags encoded in the high priority message of all Maxicodes:

<u>Tag</u>	<u>Definition</u>	<u>Default Value</u>
POST	Postal or ZIP Code	-empty-
CC	Country Code (from ISO 3166)	840 (USA)
SC	Service Class	1

Tags to control the type of barcode created:

<u>Tag</u>	<u>Definition</u>	<u>Default Value</u>
UPS5	Use UPS5 tags to create the low priority message. (On: 1, Off: 0)	0
ZIPPER	Turn the zipper and contrast patterns on or off. (On: 1, Off: 0)	0
FILLC	Low priority message fill character (Messages shorter than 84 characters will be padded with this character.)	!

Tags used when UPS5 is turned off:

<u>Tag</u>	<u>Definition</u>	<u>Default Value</u>
MSG	Low priority message field (maximum of 84 characters, overwritten by UPS5 tags)	-empty-

Tags used when UPS5 is turned on:

<u>Tag</u>	<u>Definition</u>	<u>Default Value</u>
LPMS	Low priority message header]>[RS]
HEAD	Transportation data format header	01[GS]98
TN	Tracking Number	[GS]
SCAC	Standard Carrier Alpha Code	UPSN
SHIPPER	UPS Shipper Number	[GS]
PICKDAY	Julian day of pickup	[GS]
SHIPID	Shipment ID Number	[GS]
NX	Package N of X (n/x)	[GS]
WEIGH	Package weight	[GS]
VAL	Address validation (Y or N)	[GS]
STADDR	Ship to street address	[GS]
CITY	Ship to city	[GS]
ST	Ship to state	[GS]
EXTRA	Extra user defined fields	- empty -
EOT	End of transmission character	0x004h
GS	Field separator character [GS]	0x01Dh
RS	Format type separator [RS]	0x01Eh

Please see the document “*Guide to Bar Coding with UPS OnLine: for Customers Generating Bar Code Labels, Version 5*” available from the United Parcel Service for more information on creating labels for the UPS shipping system.

MAXICODE Examples

Basic example with minimal required fields to print a barcode:

```
! 0 200 200 600 1  
JOURNAL  
B MAXICODE 20 20  
CC 12345  
MSG This is a MAXICODE low pri-  
ority message.  
SC 12345  
POST 02886  
ENDMAXICODE  
PRINT
```

Output:

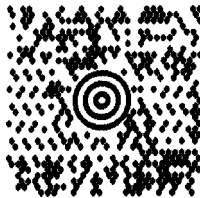

Decodes to:

```
028860000[GS]057[GS]057[GS]This is a  
MAXICODE low priority message.
```

Same example with zipper and contrast patterns:

```
! 0 200 200 600 1  
JOURNAL  
B MAXICODE 20 20  
CC 12345  
MSG This is a MAXICODE low pri-  
ority message.  
SC 12345  
POST 02886  
ZIPPER 1  
ENDMAXICODE  
PRINT
```

Output:

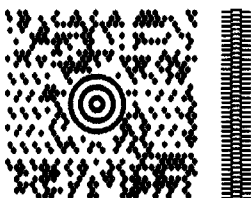

Example using tags for UPS:

```
! 0 200 200 600 1
JOURNAL
B MAXICODE 20 20
VAL Y
STADDR 30 PLAN WAY
WEIGH 210
SHIPID 42
PICKDAY 193
SHIPPER 12345
TN 1Z12345675
CC 860
SC 1
POST 02886
ZIPPER 1
SHIPPER 12345E
NX 1/2
UPS5 1
CITY WARWICK
ST RI
ENDMAXICODE
PRINT
```

Output:

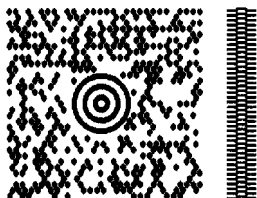

Decodes to:

```
[ ]>[RS]01[GS]98028860000[GS]860[GS]001[GS]1Z12
345675[GS]USPN[GS]12345E[GS]193[GS]42[GS]1/2[
GS]210[GS]Y[GS]30 PLAN WAY[GS]WARWICK[GS]
RI[RS][EOT]
```

GRAPHICS

BOX Command

The BOX command provides the user with the ability to produce rectangular shapes of specified line thickness.

Format:

{command} *{x₀}* *{y₀}* *{x₁}* *{y₁}* *{width}*

where:

{command}: BOX

{x₀}: X-coordinate of the top left corner.

{y₀}: Y-coordinate of the top left corner.

{x₁}: X-coordinate of the bottom right corner.

{y₁}: Y-coordinate of the bottom right corner.

{width}: Unit-width (or thickness) of the lines forming the box.

BOX Example

Input (BOX.LBL):

```
! 0 200 200 210 1
BOX 0 0 200 200 1
FORM
PRINT
```

Output:

0,0



200,200

Note: Text coordinates (in output) are shown for illustration purposes only.

LINE Commands

Lines of any length, thickness, and angular orientation can be drawn using the LINE command.

Format:

{command} {x₀} {y₀} {x₁} {y₁} {width}

where:

{command}: Choose from the following:

LINE Prints a line.
(or L)

{x₀}: X-coordinate of the top-left corner.

{y₀}: Y-coordinate of the top-left corner.

{x₁}: X-coordinate of:
- top right corner for horizontal.
- bottom left corner for vertical.

{y₁}: Y-coordinate of:
- top right corner for horizontal.
- bottom left corner for vertical.

{width}: Unit-width (or thickness) of the line.

LINE Example

Input (LINE.LBL):

```
! 0 200 200 210 1
LINE 0 0 200 0 1
LINE 0 0 200 200 2
LINE 0 0 0 200 3
FORM
PRINT
```

Output:

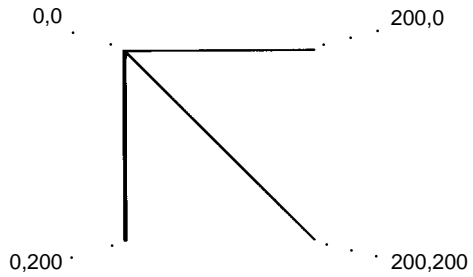

Note: Text coordinates (in output) are shown for illustration purposes only.

INVERSE-LINE Commands

The INVERSE-LINE command has the same syntax as the LINE command. Previously created objects that lie within the area defined by the INVERSE-LINE command will have their black areas re-drawn white, and white areas re-drawn black. These objects can include text, barcodes and/or graphics, including downloaded .pcx files. INVERSE-LINE has no effect on objects created after its location, even if they fall within its covered area. In example INVERSE2.LBL, portions of the text field created after the INVERSE-LINE command remain black, hence invisible, even though placed within the INVERSE-LINE area.

Format:

{command} {x0} {y0} {x1} {y1} {width}

where:

{command}: Choose from the following:

INVERSE-LINE (or IL)	Prints a line over an existing field to invert the image.
-------------------------	--

{x0}: X-coordinate of the top-left corner.

{y0}: Y-coordinate of the top-left corner.

{x1}: X-coordinate of:
- top right corner for horizontal.
- bottom left corner for vertical.

{y1}: Y-coordinate of:
- top right corner for horizontal.
- bottom left corner for vertical.

{width}: Unit-width (or thickness) of the inverse-line.

INVERSE-LINE Examples

Input 1 (INVERSE1.LBL):

```
! 0 200 200 210 1
CENTER
TEXT 4 0 0 45 SAVE
TEXT 4 0 0 95 MORE
INVERSE-LINE 0 45 145 45 45
INVERSE-LINE 0 95 145 95 45
FORM
PRINT
```

Output 1:

SAVE
MORE

Input 2 (INVERSE2.LBL):

```
! 0 200 200 210 1
T 4 2 30 20 $123.45
T 4 2 30 70 $678.90
IL 25 40 350 40 90
T 4 2 30 120 $432.10
FORM
PRINT
```

Output 2:

\$123.45
\$678.90
\$432.10

PATTERN Command

The PATTERN command is used with the LINE and SCALE-TEXT commands to change the patterns used to fill these shapes. Valid pattern values are listed below.

Format:

{command} {pattern number}

where:

{command}: PATTERN

{pattern number}: Choose from the following:

100	Filled (solid black/default pattern).
101	Horizontal lines.
102	Vertical lines.
103	Right rising diagonal lines.
104	Left rising diagonal lines.
105	Square pattern.
106	Cross hatch pattern.

PATTERN Example

Input (PATTERN.LBL):

```
! 0 200 200 700 1
; Draw horizontal and vertical patterns
PATTERN 101
LINE 10 10 160 10 42
PATTERN 102
LINE 170 10 350 10 42
; Draw left and right diagonal patterns
PATTERN 103
LINE 10 65 160 65 40
PATTERN 104
LINE 170 65 350 65 40
; Draw square and cross hatch patterns
PATTERN 105
LINE 10 115 160 115 40
PATTERN 106
LINE 170 115 350 115 40
; Draw a scalable text character with cross
; hatch pattern
PATTERN 106
ST PLB_LAT.CSF 40 40 20 180 HELLO
FORM
PRINT
```

Output:

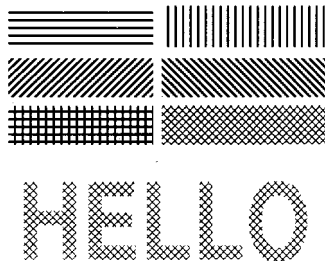

GRAPHICS Commands

Bit-mapped graphics can be printed by using graphics commands. ASCII hex (hexadecimal) is used for expanded graphics data (see example). Data size can be reduced to one-half by utilizing the COMPRESSED-GRAPHICS commands with the equivalent binary character(s) of the hex data.

Format:

{command} {width} {height} {x} {y} {data}

where:

{command}: Choose from the following:

EXPANDED-GRAPHICS (or EG)	Prints expanded graphics horizontally.
VEXPANDED-GRAPHICS (or VEG)	Prints expanded graphics vertically.
COMPRESSED-GRAPHICS (or CG)	Prints compressed graphics horizontally.
VCOMPRESSED-GRAPHICS (or VCG)	Prints compressed graphics vertically.

{width}: Byte-width of image.

{height}: Dot-height of image.

{x}: Horizontal starting position.

{y}: Vertical starting position.

{data}: Graphics data.

PCX Commands

The PCX command gives a user the ability to send ".PCX" graphics formatted images to the printer. The .PCX image MUST be encoded as a black and white image.

Format:

```
{command} {x} {y}  
{data}
```

where:

{command}: PCX

{x}: X-coordinate of the top-left corner.

{y}: Y-coordinate of the top-left corner.

{data}: PCX image data.

PCX Examples

EXAMPLE 1

In the example below, the image is sent in three steps. First, the printer is sent commands to expect a .PCX formatted file. The second input to the printer is the .PCX image. This image must be a 2 color (black and white) image. The last step is to tell the printer to print the label.

Input 1 (STARTPCX.LBL):

```
! 0 200 200 500 1  
PCX 0 30
```

Input 2 (IMAGE.PCX)

Input 3 (ENDPCX.LBL)

```
FORM  
PRINT
```

Output:



PCX Examples continued

EXAMPLE 2

In this example , the PCX image has been loaded into the printer's flash file system and given the name "IMAGE.PCX". The "!<" operator can now be used to instruct the printer to get the data stored in the file "Image.PCX" and use it for building the image.

Input 2 (IMAGE.LBL):

```
! 0 200 200 500 1
PCX 0 30 !<IMAGE.PCX
FORM
PRINT
```

Output:



ADVANCED COMMANDS

CONTRAST Command

The CONTRAST command is used to specify the print darkness for the entire label. The lightest printout is at contrast level 0. The darkest contrast level is 3. The printer defaults to contrast level 0 on power up. Contrast level must be specified for each label file.

In order to maximize printing efficiency, always use the lowest contrast level possible .

Format:

{command} {level}

where:

{command}: CONTRAST

{level}: Contrast level.

0 = Default

1 = Medium

2 = Dark

3 = Very Dark

TONE Command

The TONE Command can be used instead of the CONTRAST command to specify the print darkness for all labels. The lightest printout is at tone level -99. The darkest tone level is 200. The printer defaults to tone level 0 on power up. Tone level settings remain in effect for all printing tasks until changed. The TONE and CONTRAST commands *cannot* be used in combination with one another.

Format:

{command} {level}

where:

{command}: TONE

{level}: select a value from -99→200.

Contrast to Tone level equivalents.

Contrast 0 = Tone 0 Contrast 1 = Tone 100

Contrast 2 = Tone 200 Contrast 3 = No equivalent

JUSTIFICATION Commands

Alignment of fields can be controlled by using the justification commands. By default, the printer will left justify all fields. A justification command remains in effect for all subsequent fields until another justification command is specified.

Format:

{command} [end]

where:

{command}: Choose from the following:

CENTER Center justifies all subsequent fields.

LEFT Left justifies all subsequent fields.

RIGHT Right justifies all subsequent fields.

[end]: End point of justification. If no parameter is entered, justification commands use the print head's width for horizontal printing or zero (top of form) for vertical printing.

JUSTIFICATION Example

Input (JUSTIFY.LBL):			
!	0	200	200 210 1
CENTER	383		
TEXT	4	0 0	75 C
LEFT			
TEXT	4	0 0	75 L
RIGHT	383		
TEXT	4	0 0	75 R
FORM			
PRINT			
Output:	L	C	R

PAGE-WIDTH Command

The printer assumes that the page width is the full width of the printer. The maximum height of a print session is determined by the page width and the available print memory. If the page width is less than the full width of the printer, the user can increase the maximum page height by specifying the page width.

Note: This command should be issued at the beginning of a print session.

Format:

{command} {width}

where:

{command}: Choose from the following:

PAGE-WIDTH Specifies page width.
(or PW)

{width}: Unit-width of the page.

PAGE-WIDTH Example

Input 1 (PW1.LBL):

```
! UTILITIES  
SETLP 7 0 15  
PW 300  
PRINT
```

This text is printed with label memory width set to 300 dots.

Output 1:

```
This text is printed with  
label memory width set t  
o 300 dots.
```

Input 2 (PW2.LBL):

```
! UTILITIES  
SETLP 7 0 15  
PW 200  
PRINT
```

This text is printed with label memory width set to 200 dots.

Output 2:

```
This text is prin  
ted with label me  
mory width set to  
200 dots.
```

PACE Command

This command can be used with batch printing. When PACE is activated, the user must depress the printer's "FEED" key to print additional labels until the batch quantity is exhausted. By default, pacing is disabled on power up.

Format:

{command}

where:

{command}: PACE

PACE Example

In the following example, the command file shown was sent to the printer once. The two additional printouts were produced by pressing the 'FEED' key once for each additional printout.

Input (PACE.LBL):

```
! 0 200 200 210 3
; Tell printer to print a label
; after each 'FEED' key press
; until all 3 labels are printed
PACE
; Printer holds journal stock
JOURNAL
; Center the text
CENTER
TEXT 4 1 0 10 Print 3 labels
TEXT 4 1 0 90 Using PACE
PRINT
```

Output:



Print 3 labels
Using PACE

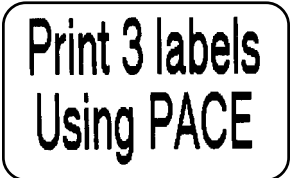

Print 3 labels
Using PACE



Print 3 labels
Using PACE

AUTO-PACE Command

This command can be used to instruct a printer equipped with a label presentation sensor to delay printing until the previously printed label is removed.

Format

{command}

Where:

{command}: AUTO-PACE

AUTO-PACE Command Example

This example instructs the printer to print 10 labels. The printer prints a label, and waits for that label to be removed before printing the next label.

Input (APACE.LBL):

```
! 0 200 200 250 10  
CENTER  
TEXT 7 0 0 10 AUTO-PACE EXAMPLE  
AUTO-PACE  
FORM  
PRINT
```

NO-PACE Command

This command cancels the PACE and AUTO-PACE mode, if the printer is already in PACE or AUTO-PACE. The printer defaults to NO-PACE on power up.

format: {command}

where: {command}: NO-PACE

NO-PACE Command Example

This example instructs the printer to print 10 labels. The printer prints a label, waits for the label to be removed before printing the next label. The second set of 10 labels will be printed in batch mode and the printer will not wait for the operator to remove the labels.

Input (NO-PACE.LBL):

```
! 0 200 200 250 10
TEXT 7 0 0 10 AUTO-PACE EXAMPLE
AUTO-PACE
FORM
PRINT
! 0 200 200 250 10
TEXT 7 0 0 10 NO-PACE EXAMPLE
NO-PACE
FORM
PRINT
```

WAIT Command

This command is used to introduce a delay after a label is printed.

Format

{command} {delay-time}

where:

{command}: WAIT

{delay-time}: Delay time in 1/8 seconds.

WAIT Command Example

In the example below, the printer will pause 10 seconds (10 * 8 = 80) after printing each label.

```
INPUT (WAIT.LBL):  
  
! 0 200 200 150 5  
WAIT 80  
TEXT 5 0 0 20 DELAY 10 SECONDS  
FORM  
PRINT
```

REWIND Command

This command is used to turn the rewind (or take-up) motor on or off. The printer defaults to REWIND-ON on power up. The REWIND command is ignored by printers that are not equipped with a motorized rewind.

format: {command}

where: {command}: Choose one of the following:

REWIND-OFF

REWIND-ON

REWIND Command Example

```
INPUT (REWIND.LBL):  
  
! 0 200 200 150 1  
REWIND-OFF  
TEXT 5 0 0 20 TURNS REWIND OFF  
PRINT
```

TENSION Commands

The tension commands are used to adjust the liner tension before and/or after printing a label by running the rewind motor for a pre-specified length. This adjustment improves peeler performance of printers equipped with a motorized rewind mechanism. The TENSION commands are ignored by printers not equipped with a motorized rewind.

Format

{command} {length}

where:

{command}: Choose one of the following:

PRE-TENSION: Perform tension adjustment prior to printing the label.

POST-TENSION: Perform tension adjustment after printing the label.

{length}: The unit length the rewind motor should advance to tighten the liner tension. The rewind motor will slip once tension is adjusted (it will not pull the stock out of adjustment for the next print cycle).

TENSION Command Example

In this example, the printer is instructed to run the rewind motor for 30 dot-lines, removing any slack in the liner to adjust the liner tension prior to printing the label.

Input (TENSION.LBL):

```
! 0 200 200 150 1
PRE-TENSION 30
TEXT 5 0 0 20 ADJUSTS TENSION
```

SPEED Command

This command is used to set the highest motor speed level. Each printer model is programmed with a minimum and maximum attainable speed. The SPEED command selects a speed level within a range of 0 to 5, with 0 the slowest speed. The maximum speed programmed into each printer model is attainable only under ideal conditions. The battery or power-supply voltage, stock thickness, print darkness, applicator usage, peeler usage, and label length are among the factors that could limit the maximum attainable print speed.

WARNING: By exercising this command the user overrides the factory programmed speed for the label being printed, which may adversely affect print quality. If print quality suffers using the current SPEED setting, the printer speed should be reduced.

Format

{command} {speed level}

where:

{command}: SPEED

{speed level}: A number between 0 and 5, 0 being the slowest speed.

SPEED Command Example

Input (SPEED.LBL):

```
! 0 200 200 150 1
```

```
SPEED 4
```

```
TEXT 5 0 0 20 PRINTS AT SPEED 4
```

```
FORM
```

```
PRINT
```

SETSP Command

The SETSP command is used to change spacing between text characters.

Format:

{command} {spacing}

where:

{command}: SETSP

{spacing}: Unit measurement between characters. The default for spacing is zero. Note that this command is affected by the UNITS command setting.

SETSP Command Example

Input (SETSP.LBL):

```
! 0 200 200 210 1
T 4 0 0 10 Normal Spacing
SETSP 5
T 4 0 0 50 Spread Spacing
SETSP 0
T 4 0 0 90 Normal Spacing
FORM
```

Output:

```
Normal Spacing
Spread Spacing
Normal Spacing
```

ON-OUT-OF-PAPER Command

This command can be issued to instruct the printer as to the course of action to take when it encounters an error while printing the label (such as running out of stock)

format: {command} {action} {number of retries}

where: {command}: ON-OUT-OF-PAPER

{action}: Choose one of the following:

PURGE: Discard the label if print error is encountered after the specified number of attempts.

WAIT: Do not discard the label if print error is encountered. In this mode the printer will wait for the error to be corrected before making the next print attempt.

{number of retries}: n: Specify how many times the printer should attempt to print the label.

The default printer configuration is:
ON-OUT-OF-PAPER PURGE 2

ON-OUT-OF-PAPER Command Example

This example instructs the printer to attempt to print the label twice.

Input (OOP.LBL):

```
! 0 200 200 150 1
ON-OUT-OF-PAPER WAIT 2
TEXT 5 0 0 20 MAKE TWO ATTEMPT
FORM
PRINT
```

ON-FEED Command

Your printer can be configured to ignore, form-feed, or reprint the last label when the feed key is pressed or when it receives a form-feed character (0x0c).

Format:

{command} {action}

where:

{command}: ON-FEED

{action}: Choose from the following:

- | | |
|---------|--|
| IGNORE | Don't take any action when the feed key is pressed or when the form-feed character is received. |
| FEED | Feed to top-of-form when the feed key is pressed or when the form-feed character is received. |
| REPRINT | REPRINT the last label when the feed key is pressed or when the form-feed character is received. |

In the following example, the command file shown was sent to the printer only once. The two additional labels were produced by pressing the printer 'FEED' key once for each additional label.

ON-FEED Example

Input (ONFEED.LBL):

```
! 0 200 200 300 1
ON-FEED REPRINT
CENTER
JOURNAL
TEXT 4 1 0 20 PRESS FEED KEY
TEXT 4 1 0 100 TO REPRINT
TEXT 4 1 0 180 THIS TEXT
PRINT
```

Output:

PRESS FEED KEY
TO REPRINT
THIS TEXT

PRESS FEED KEY
TO REPRINT
THIS TEXT

PRESS FEED KEY
TO REPRINT
THIS TEXT

PREFEED Command

The PREFEED command instructs the printer to advance the media a specified amount prior to printing.

Format:

{command} {length}

where:

{command}: PREFEED

{length}: Unit length the printer advances media prior to printing.

PREFEED Command Example

The following example sets up the printer for pre-feeding 40 dot-lines prior to printing.

```
Input (PREFEED.LBL):  
  
! 0 200 200 210 1  
PREFEED 40  
TEXT 7 0 0 20 PREFEED EXAMPLE  
FORM  
PRINT
```

POSTFEED Command

The POSTFEED command instructs the printer to advance the media a specified amount after printing.

Format:

{command} {length}

where:

{command}: POSTFEED

{length}: Unit length the printer advances media after printing.

POSTFEED Command Example

The following example sets up the printer for post-feeding 40 dot-lines after printing.

Input (POSTFEED.LBL):

```
! 0 200 200 210 1
TEXT 7 0 0 20 POSTFEED EXAMPLE
FORM
POSTFEED 40
PRINT
```

PRESENT-AT Command

The PRESENT-AT command can be used to position the media at the tear bar of the printer or at a location where the printed label can be easily removed by the operator. When a PRESENT-AT command is issued, the printer will print a label and then, after a delay period, advance the media a specified distance. It will then retract the media the same distance before starting a new print job.

The “delay” parameter is used to avoid unnecessary advance/retract operations when printing a batch of print jobs. The PRESENT-AT command can be issued in a label file or in a utilities command session (!UTILITIES...PRINT)

Caution: When using this command an added buffer area of 18 dots should be applied to the leading and trailing edges of the label. Registration between any preprinting graphics on the media and the file being printed may vary from label to label .

Format:

{command} {length} {delay}

where:

{command}: PRESENT-AT

{length}: Unit length in dot-lines the media is advanced after printing and retracted before printing the next label.

{delay}: The interval after printing the label the printer waits prior to advancing the media. Increments are in 1/8 of a second. A delay of “1” is equivalent to 1/8th of a second. A delay of “4” is equivalent to 1/2 second, etc.

PRESENT-AT Command Example

The following example instructs the printer to wait 1/4 second and if there is no printer activity within this interval to then advance the media 80 dot-lines. The printer will retract the media by the same amount before printing the next label.

Input (PRESENT-AT.LBL):

```
! 0 200 200 250 1
TEXT 7 0 0 10 PRESENT-AT EXAMPLE
PRESENT-AT 80 2
FORM
PRINT
```

COUNTRY / CODE PAGE Command

The COUNTRY control command substitutes the appropriate character set for the specified country.

Format:

{command} {name}

where:

{command}: COUNTRY

{name}: Choose from the following:

USA

GERMANY

FRANCE

SWEDEN

SPAIN

NORWAY

CHINA (double byte encoding)

ITALY

CP850

UK

BIG5 (Traditional Chinese; double byte encoding)

JAPAN-S (Simplified Japanese fonts; double byte encoding)

COUNTRY / CODE PAGE Example

Input (COUNTRY.LBL):

```
! 0 200 200 80 1
IN-MILLIMETERS
JOURNAL
CENTER
; Set the country as USA
COUNTRY USA
; Now Print Text From ISO sub-
stitution Table
TEXT 4 0 0 8 COUNTRY IS USA
TEXT 4 0 0 15 #${@[ \ ] ^ { | } ~}
; Set country for France and
print the same text
COUNTRY FRANCE
TEXT 4 0 0 28 COUNTRY IS FRANCE
TEXT 4 0 0 35 #${@[ \ ] ^ { | } ~}
PRINT
```

Output:

COUNTRY IS USA

#\${@[\] ^ { | } ~}

COUNTRY IS FRANCE

£\$à°ç§^µèùè"

USING FORMAT FILES

The DEFINE-FORMAT and USE-FORMAT commands are used to identify format and data respectively.

Format files eliminate having to re-send the same format information for every label printed. By using a pre-loaded format, only variable data (such as descriptions, price, etc.) is sent to the printer.

Input (NOFORMAT.LBL):

! 0 200 200 210 1

CENTER

TEXT 4 3 0 15 \$22.99

TEXT 4 0 0 95 SWEATSHIRT

BARCODE UPCA 1 1 40 0 145 40123456784

TEXT 7 0 0 185 40123456784

FORM

PRINT

Output:

\$22.99

SWEATSHIRT



40123456784

The following pages illustrate separating the above example into a format file and data.

USING FORMAT FILES (continued)

Defining a label format file is accomplished using the DEFINE-FORMAT (or DF) command to mark the beginning of the format, and PRINT to mark the end. A '\\' (double-backslash) acts as a place holder for data.

Input (FORMATF.LBL):

```
! DF SHELF.FMT
! 0 200 200 210 1
CENTER
TEXT 4 3 0 15 \\
TEXT 4 0 0 95 \\
BARCODE UPCA 1 1 40 0 145 \\
TEXT 7 0 0 185 \\
FORM
PRINT
```

The USE-FORMAT (or UF) command instructs the printer to use a specified format file. The label will be created using that format file with data supplied following the USE-FORMAT command. After accessing the specified format file, the printer substitutes the '\\' delimiters with the data supplied, producing the desired label.

Input (FORMATD.LBL):

```
! UF SHELF.FMT
$22.99
SWEATSHIRT
40123456784
40123456784
```

USING FORMAT FILES (continued)

As with all print commands, each line in a format file and its accompanying variables must be terminated with the carriage-return **and** line-feed character sequence.

Once defined, a format will remain in the printer's non-volatile memory for future reference. An existing format can be changed by over writing the file. By using the DEL command, the format file can be deleted.

Format file names can consist of no more than 8 letters or digits, and format file extensions can be no more than 3 letters or digits. Any lowercase letter in the format file name or extension will be converted to upper case.

Note: Every time a file is created on the printer using the "! DEFINE-FORMAT...", "! DF..." or the Visual Label Utility application, for example, the file information is written to flash memory. Unlike RAM, flash memory does not require battery for retaining data, and is immune to data corruption due to static discharge. Although flash memory is superior to RAM for safe-guarding file contents, it is limited to an average of 10,000 write cycles (i.e. file creations). For this reason, the user should exercise the file creation commands such that the stated limit is not exceeded.

BEEP Command

This command instructs the printer to sound the beeper for a given time length. Printers not equipped with a beeper will ignore this command.

Format:

{command} {beep_length}

Where:

{command}: BEEP

{beep_length}: Duration of beep, specified in
 .125 (1/8th) second incre

ments.

BEEP Command Example

This example instructs the printer to beep for two seconds (16 x .125 seconds = 2 seconds)

Input (BEEP.LBL):

```
! 0 200 200 210 1
CENTER
TEXT 5 0 0 10 BEEPS FOR TWO SECONDS
BEEP 16
FORM
PRINT
```

CUT Command

On printers equipped with cutters, this command will cut the label after it is printed.

Format:

{command}

where:

{command}: CUT

CUT Example

Input (CUT.LBL):

```
! 0 200 200 1.5 1
IN-INCHES
; Journal label 300 dots long
CENTER
; Print some text
TEXT 4 0 0 .15 CUT COMMAND
TEXT 4 0 0 .5 EXAMPLE
; After we print the label, cut it.
CUT
PRINT
```

PARTIAL-CUT Command

On printers equipped with cutters, this command will cut the label after it is printed, leaving a portion of the label uncut to facilitate easily tearing the remainder of the label.

Format:

{command}

where:

{command}: PARTIAL-CUT

PARTIAL-CUT Example

Input (PCUT.LBL):

```
! 0 200 200 1.5 1
IN-INCHES
; Journal label 300 dots long
JOURNAL
CENTER
; Print some text
TEXT 4 0 0 .15 PARTIAL CUT
TEXT 4 0 0 .5 EXAMPLE
; After we print the label, partially cut the
label.
PARTIAL-CUT
PRINT
```

CUT-AT Command

This command is used on printers equipped with a cutter, in conjunction with the CUT or PARTIAL-CUT commands. This command will instruct the printer to retract the stock by a specified length. Printers not equipped with a cutter will ignore this command. This command should not be used on printers that use a thermal transfer ribbon.

Format: {command} {length}

Where: {command}:
CUT-AT

{length}: The unit length the stock should be retracted after performing a cut or partial cut.

CUT-AT Command Example

This example instructs the printer to print a label, perform a form-feed, cut the label, and retract the stock by 100 dot-lines.

```
Input (CUTAT.LBL):
```

```
! 0 200 200 250 1
```

```
CENTER
```

```
TEXT 7 0 0 20 CUT-AT EXAMPLE
```

```
CUT
```

```
CUT-AT 100
```

```
FORM
```

```
PRINT
```

MCR Commands

These commands (MCR, MCR-QUERY and MCR-CAN) can be used to configure and activate the optional Magnetic Card Reader (MCR). The MCR commands will be ignored by printers that are not equipped with a Magnetic Card Reader.

The MCR command can be issued in a label file (! 0 200 ... PRINT), or in a utilities command session (! UTILITIES ... PRINT). Refer to the discussion of the MCR commands in Section 10 (Advanced Utilities) of this manual for complete information on using the MCR option.

LINE PRINT MODE

Introduction

Besides printing labels, Zebra mobile printers can make receipts, lists, and other variable length documents in line printer mode. A printer in line print mode receives raw ASCII text, and will print out your document in raw text. In Windows 95, this is called the “Generic/Text Only” printer.

A printer in line print mode can interpret special commands to change the font, the spacing of characters, or even to print out bar codes and graphics. Receipts can be just as ornate and detailed as your most complex label design.

In line print mode, the printer will use the spacing, fonts, and form-feed instructions in a raw text ASCII file. The printer will interpret line feed and carriage returns as well as form feed characters. It will **not** print tab characters. In label mode, the user must provide a X and Y coordinate for every item on the label. In line print mode, the printer can automatically calculate these coordinates or use the ones the user provides.

This section explains how to use line print mode to its full advantage. It covers the basics of how to use utility commands and the most commonly used commands to create receipts. The end of this section includes sample files and results as well as how to design a unique and professional receipt.

It is assumed that the user knows how to communicate with the printer and how to create a basic ASCII file using a text editor like DOS ‘EDIT’ or Windows™ Notepad.

Note: Line print mode is not available in devices running EPL (Eltron printer emulation), ZPL (Zebra printer emulation) or PECTAB versions of printer applications.

Special Commands Using the Utility Function

The printer can execute several utility commands at once or one at a time.

```
! U
SETLP 7 0 24
PAGE-WIDTH 720
PRINT
```

This line is printed as raw text.
These lines are in font 7 size 0

```
! U1 SETLP 7 0 24
! U1 PAGE-WIDTH 720
```

This line is printed as raw text.
These lines are in font 7 size 0.

The “! UTILITIES” command, or “! U” for short, must be ended by the terminator “PRINT” followed by a CR/LF (Carriage Return/Line Feed, or “Enter”) to end the utility session. The “! U1” command only executes one utility command and must be followed by a CR/LF. Also, the “! U1” command can be placed ANYWHERE in a text line to execute the command.

Example:

Although this text is all on the same line, ! U1 SETLP 5 0 24 (CR/LF) this font is new.

Although this text is all on the same line, **this font is new.**

To change the default settings for the printer, any of these commands can be placed in an AUTOEXEC.BAT file. Please see the “Batch Files” section in “Printer Configuration and Setup” in the Programming Manual Section 13.

UNITS Commands

The units commands specify a measurement system for all subsequent command fields in a utility session. Coordinates, widths, and heights for all utility commands can be entered with precision to four decimal places. The printer measurement system will default to dots until a units command is issued.

Format:

```
<!/ <UTILITIES>  
{command}  
<PRINT>
```

where:

{command}: Choose from the following:

IN-INCHES	Measurement in inches.
IN-CENTIMETERS	Measurement in centimeters.
IN-MILLIMETERS	Measurement in millimeters.
IN-DOTS	Measurement in dots. The default unit of measurement is in dots.

SETLP Command

Selecting the line printer font (the SETLP command) will change the font the printer uses for line print mode. It also chooses the amount of space the printer will move down when the printer receives a carriage return (hex value 0x0d).

! U1 SETLP {font name or number} {size} {unit height}

The {unit height} value should be set to the actual height of the font being used. Refer to Appendix C of this manual for actual resident font height values.

SETLP allows you to use either the resident fonts or pre-scaled fonts downloaded to the flash memory. The Label Vista design software can create and upload a font for the printer from any available TrueType¹ font. Appendix D contains a table of all resident font heights and their proper unit height.

You can set the printer font multiple times when using the line printer to make a receipt. For example, to put the company name in a larger font at the top of a label, change to font 5 size 2 and then to font 7 size 0.

Example:

```
! U1 SETLP 5 2 46
AURORA'S FABRIC SHOP
! U1 SETLP 7 0 24
123 Castle Drive, Kingston, RI 02881
(401) 555-4CUT
```

AURORA'S FABRIC SHOP

123 Castle Drive, Kingston, RI 02881
(401) 555-4CUT

¹ TrueType is a registered trademark of Apple Computers, Inc.

SETLF Command

Use the SETLF command to change the height of each line without changing the font.

! U1 SETLF {unit height}

The command “! U1 SETLF 40” will advance the paper 40 dots for every LF (line feed, hex value 0x0a) character it receives.

SETLF Command Example

Input (SETLF2.LBL):

```
! U SETLP 4 0 40
SETLF 40
PRINT
Output 2
Text line
Text line
Text line
```

Output : **Output 2**
 Text line
 Text line
 Text line

Moving With X and Y Coordinates

Even though the printer is in a line print mode, it can still move down and across the paper using X and Y values.

```
! U1 X {unit value}
! U1 Y {unit value}
! U1 XY {x unit value} {y unit value}
! U1 RX {unit x value to move relative to present
position}
! U1 RY {unit y value to move relative to present
position}
! U1 RXY{unit x value to move relative to present
position} {unit y value to move relative to present posi-
tion}
```

This command is useful for moving across the paper without using extra spaces or moving down the paper without needing to set the SETLF command to a specific value.

Negative values cannot be used for “Y” coordinates.

LMARGIN Command

The LMARGIN command sets the left margin in line print mode. Instead of issuing several X commands or inserting spaces, the LMARGIN command moves everything over the number of dots you choose.

```
! U1 LMARGIN {dots to offset from left}
```

This function can be used with the PAGE-WIDTH command. LMARGIN will move the left margin over the set number of dots from the automatically calculated side of the paper.

SETBOLD Command

The SETBOLD command will make text bolder and slightly wider. The SETBOLD command takes one operand to set how black the text should be made.

```
! U1 SETBOLD {value}
```

where {value} is an offset number from 0 to 5.

Note that {value} will be in the units set by the UNITS command.

The default UNITS setting is in dots. (203 dots= 1")

If UNITS is in inches the offset value range is 0-.0246".

If UNITS is in centimeters the offset value range is 0-.0625 cm.

If UNITS is in millimeters the offset value range is 0-.625 mm.

Be sure to issue a "! U1 SETBOLD 0" command to turn the bolding off when done.

Example:

```
! U1 SETBOLD 2
```

```
This text is in bold ! U1 SETBOLD 0  
but this text is normal.
```

This text is in bold but this text is normal.

SETSP Command

The SETSP command is used to change spacing between text characters. Spreading out characters on a line

makes the font appear wider. The SETSP command can also be used to spread out the text across the line.

`! U1 SETSP {unit to separate characters}`

For example, “! U1 SETSP 5” will put five dots between each character on the line. Try this command to make fonts look larger for emphasis. Note that this command is affected by the UNITS command setting. (Refer to the SETBOLD command above.)

Example:

```
Normal Text ! U1 SETSP 5  
SPREAD OUT TEXT
```

```
Normal Text SPREAD OUT TEXT
```

PAGE-WIDTH Command

PAGE-HEIGHT Command

The printer lets you control both the width and height of the page through use of the PAGE-WIDTH and PAGE-HEIGHT commands. The Encore four inch printers, for example, will take any size stock up to four inches wide. If the stock is three inches wide, use the PAGE-WIDTH, or PW command.

! U1 PW {unit width}

If the size of the receipts should remain a constant and the paper stock does not have a black bar to denote the top of form, use the PAGE-HEIGHT, or PH command. The printer will then partition the data you send into fixed page sizes.

! U1 PH {unit height}

Special ASCII Characters

Form Feed

ASCII Character (0x0c) will advance the paper to either the next index mark, or the length specified by the PAGE-HEIGHT, SETFF or SET-TOF commands. (The index mark is either a black line on the back of the stock, or the gap between labels. See GAP-SENSE or BAR-SENSE in Section 12 of this manual.)

Backspace

ASCII Character (0x08) acts as a non-destructive backspace. The character after the backspace character will appear on top of the previous character.

SETFF Command

The SETFF command is used to align top of media to print head. Once this command is executed, the alignment will occur when :

- feed key is pressed.
- form-feed character (0x0c) is issued.
- FORM command is issued.

Format:

```
<!/ <UTILITIES>  
{command} {max-feed} {skip-length}  
<PRINT>
```

where:

{command}: SETFF

{max-feed}: Maximum unit-length the printer advances searching for the next eye-sense mark to align top of form. Valid values are 0-20,000.

{skip-length}: Unit-length printer advances past top of form. Valid values are 5-50.

SETFF Command Example

The following example programs the printer to advance the paper until the eye-sense mark is found, or the paper has been advanced a maximum of 25 millimeters. If an eye-sense mark is found, the paper will be advanced an additional 2.5 millimeters.

Input (SETFF.LBL):

```
! UTILITIES  
IN-MILLIMETERS  
SETFF 25 2.5  
PRINT
```

SET-TOF Command

This command is used to program the distance between the top-of-form and the end of the next (positive value) or previous (negative value) eye-sense mark or gap. The eye-sense-mark or gap that is closer to the top-of-form should be used for top-of-form setting.

Format:

{command} {d}

where:

{command}: SET-TOF

{d}: The distance between the top of form and the end of the next or previous eye-sense mark or gap, which ever is closer. The specified value should be negative if the previous eye-sense mark is used as reference, or positive if the next eye-sense mark is used.

The following are the maximum values (in DOTS) that can be specified for each model in Zebra's Mobile Printer line:

Cameo 2 & 3	79
Encore 2& 3	119
Encore 4	127
MP5022 & MP5033	101
MP5044	133
QL 220	89
QL 320	116
QL 420	106
RP3	142

SET-TOF Command Example 1, label with eye-sense mark

The following example sets the top-of-form to end of next eye-sense mark to 101 dots (measured from the top-of-form to the end of the next (lower) label's eye-sense mark).

```
Input (SETTOF.LBL):
```

```
! UTILITIES  
SET-TOF 101  
PRINT
```

SET-TOF Command Example 2, label with gaps

The following example sets the top-of-form to end of next eye-sense-mark/gap to 0 dots (measured from the top-of-form to the end of the next (lower) label's gap).

```
Input (SETTOF2.LBL):
```

```
! UTILITIES  
SET-TOF 0  
PRINT
```

Tearing or Cutting the Paper

PRESENT-AT Command

CUT-AT Command

CUT Command

PARTIAL-CUT Command

Remember to add a few extra Carriage Return/Line Feeds (CR/LF, or Enter) to the end of your receipt. This will advance the paper enough to allow the receipt to be torn off without ripping through the last line of text. After the printer is done advancing the paper, tear the paper off.

If your printer can move stock bi-directionally, the PRESENT-AT command will advance the paper enough to rip off the receipt and not tear through the last line of text. Then, when the printer starts on the next item, it will automatically retract the paper before printing to save on paper. Using PRESENT-AT without an argument will set the units to advance to the default for that printer.

Use caution when implementing the PRESENT-AT command with preprinted media. The media may not reposition itself exactly when it is retracted prior to resuming printing, and the amount of this error is not repeatable from label to label. A buffer zone of 18 dots is recommended at the beginning and trailing edge of each receipt if PRESENT-AT is used.

```
! U1 PRESENT-AT {units to advance after print}
```

```
! U1 PRESENT-AT
```

For printers with a cutter, the CUT-AT command will advance the paper, cut, then retract back to not waste paper. Using CUT-AT without any argument will set the units to advance to the default for that printer.

! U1 CUT-AT {units to advance after print}
! U1 CUT-AT

Alternatively, the printer can simply cut the paper or partially cut the paper. (Partial cut is useful when the receipt may fall to the floor when the user doesn't grab it immediately.) At the end of the receipt, put in a sufficient amount of CR/LF characters, then issue the CUT or PARTIAL-CUT command.

! U1 CUT
! U1 PARTIAL-CUT

These commands are discussed more fully in Section 8 of this manual)

Bar Codes, Graphics and Lines

Bar Codes:

The printer can create any 1-D barcode in line print mode. The BARCODE command works just like it would in a label file. See Section 5 of this manual on the BARCODE command for more details.

The BARCODE command is affected by the justification commands like “! U1 CENTER”. See JUSTIFICATION Commands in section 8 of the manual for more information.

Graphics:

The printer can print PCX formatted graphics files in line print mode. This is not recommended, however, in order to keep print times to a minimum. The graphic should be loaded into the flash file system on the printer to achieve maximum printing speed. Please see Section 7 of this manual for more information on graphics, lines, boxes and PCX Commands.

continued on next page

Example:

```
! U1 PCX {x coordinate} {y coordinate} !<
{filename.pcx}
```

SETLP-TIMEOUT Command

If the printer does not receive any characters after a set time, it will begin to print. This delay can be set with the SETLP-TIMEOUT command.

```
! U1 SETLP-TIMEOUT {time in 1/8 second units}
```

Multiply the seconds to wait by 8 to get the correct time for the command. The valid range of values is 0-255.

Designing a Receipt

It is now possible to create a receipt using the commands just described. First, list all the fields that you want on the receipt. Will there be different types of receipts used in the business? Is this a receipt for picking up goods, or is this an itemized list of products ordered and paid for? Will there be a need to differentiate quickly between different types of receipts to prevent errors? In a nutshell, what do you need this thing to look like?

A sales receipt should contain a few basic fields to prevent confusion. First, place the business name on the top of the receipt, preferably in a font to differentiate it from everything else. Choose a large font which is either resident in the printer or custom created with the Label Vista software package. Resident font 4 size 0 or 1 and font 5 size 2 or 3 are perfect for this function. If you desire to keep the receipt size small, font 7 size 1 is tall enough to set the text apart from everything else, yet it conserves space. Set a little space between your business name and the next line.

Next, put the address and telephone number of the business under the name. Customers will appreciate not

having to flip through the phone book the next time they want to buy something from you. Also, this helps track which stores sell which items when dealing with returns and special sales promotions. Set at least two lines of space between the header and the rest of the receipt.

Consider other important items on the receipt. Add the date and time of the sale, the ID number of the cashier or salesperson. Is the action a sale, return, price adjustment, or a sales quote?

Next, the itemized bill of sale contains a SKU or UPC code, a product description, and a price. Consider using a fixed width font, or a monospaced font, for this section. A monospaced font keeps the characters an even width for every character. For example, an 'l' is the same width as an 'M' character. The resident fonts 0 and 7 are monospaced as well as other monospaced fonts available with the Label Vista software package.

Finally, at the end, many companies like to put a slogan or advertisement of coming events. Be certain to put a few CR/LF characters at the end after your final line to ensure that the bottom of the receipt does not get torn off through a printed part of the receipt.

Receipt Examples

The program must set up the file with all the spacing already inserted. Use only spaces, not tab characters, to make things line up correctly. Note that when you issue a command like “! U1 SETSP 0,” it must be followed by a CR/LF, or enter. This will not advance the printer to the next line; it will only execute the utility command.

Example 1:

```
! U1 JOURNAL
! U1 SETLP 4 0 47
  YOURCO RETAIL STORES

! U1 SETLP 7 0 24
  14:40 PM      Thursday, 06/04/20

Quantity  Item          Unit    Total
  1        Babelfish    $4.20   $4.20
          Tax:                5%     $0.21

! U1 SETSP 5
  Total: ! U1 SETSP 0
          $4.41
```

Thank you for shopping at YOURCO

YOURCO RETAIL STORES

14:40 PM Thursday, 06/04/20

```
Quantity  Item          Unit    Total
  1        Babelfish    $4.20   $4.20
          Tax:                5%     $0.21
```

Total: \$4.41

Thank you for shopping at YOURCO

The example on the next two pages is a more complex design for a fabric shop. This receipt would print at the cutting table where a salesperson measures out the fabric. The cashier then scans the barcode at the bottom of the receipt to complete the sale.

Except for the utility commands, this receipt will print out much as it looks. Your program must provide all the correct number of spaces and text alignment.

Example 2 Input:

! U1 JOURNAL
! U1 SETLP 5 2 46
 AURORA'S FABRIC SHOP
! U1 SETLP 5 0 24
 123 Castle Drive, Kingston, RI 02881
 (401) 555-4CUT
! U1 SETLP 7 0 24

4:20 PM Thursday, June 04, 2020 Store: 142
Order Number: #59285691
Status: ! U1 SETSP 10
INCOMPLETE ! U1 SETSP 0

Item	Description	Quant.	Price	Subtotal	Tax
1211	45" Buckram	5 yds @	\$3.42/yd	\$17.10	Y
Z121	60" Blue Silk	10 yds@	\$15.00/yd	\$150.00	N
Z829	60" Muslin	20 yds@	\$1.00/yd	\$20.00	Y
			SUBTOTAL:	\$187.10	
			RHODE ISLAND SALES TAX 7.00%:		\$2.60
			TOTAL:	\$189.70	

! U1 SETLP 7 1 48
PLEASE BRING THIS RECEIPT TO THE CASHIER
WITH THE REST OF YOUR PURCHASES.

! U1 CENTER
! U1 B 128 1 2 100 0 0 59285691 ST 187.10 T 2.60

Example 2 Output:

AURORA'S FABRIC SHOP

123 Castle Drive, Kingston, RI 02881
(401) 555- 4CUT

4:20 PM Thursday, June 04, 2020 Store: 142
Order Number: #59285691
Status: I N C O M P L E T E

Item	Description	Quant.	Price	Subtotal	Tax
1211	45" Buckram	5 yds @	\$3.42/yd	\$17.10	Y
Z121	60" Blue Silk	10 yds@	\$15.00/yd	\$150.00	N
Z829	60" Muslin	20 yds@	\$1.00/yd	\$20.00	Y

SUBTOTAL: \$187.10

RHODE ISLAND SALES TAX 7.00%: \$2.60

TOTAL: \$189.70

PLEASE BRING THIS RECEIPT TO THE CASHIER
WITH THE REST OF YOUR PURCHASES.



ADVANCED UTILITIES

The Advanced Utilities are used to manage the flash file system, obtain information about firmware and printer applications, configure the printer for use in other countries, and to set several operating parameters.

The following example illustrates the use of some of the commands you will find in this section. The example assumes that the printer is connected to a host computer capable of full duplex serial communication. Comments to the right are not part of the session. Comments in UPPERCASE are commands sent from the host to the printer. Comments in lower case are printer responses to the host. These commands are further explained as you read through this section.

```
! UTILITIES           START A UTILITIES SESSION  
VERSION             GET THE FIRMWARE VERSION  
6001                firmware version is 60.01  
CHECKSUM           GET APPLICATION CHECKSUM  
F723                checksum is F723  
DIR                 GET DIRECTORY OF THE  
                        FLASH FILE SYSTEM  
Directory          directory has the following 3 files  
PLL_LAT.CSF 17306  17306 byte file  
PLL_LAT.CSF 18423  18423 byte file  
AUTOEXEC.BAT 96   96 byte file  
TYPE AUTOEXEC.BAT  WHAT'S IN AUTOEXEC.BAT?  
! UTILITIES        autoexec.bat line 1  
SETLP 5 1 40      autoexec.bat line 2  
PRINT              autoexec.bat line 3  
DEL AUTOEXEC.BAT   DELETE THE AUTOEXEC.BAT FILE  
DIR                 GET A DIRECTORY OF THE FLASH  
                        FILE SYSTEM  
Directory          directory has the following 2 files  
PLL_LAT.CSF 17306  
PLB_LAT.CSF 18423  
PRINT              CLOSE THE UTILITIES SESSION
```

Note: *Text printed in italic type refers to data sent to the printer.*
Text printed in bold type refers to data sent from the printer.

VERSION Utility

This command reports the firmware version as a four character null-terminated ASCII string.

Format:

```
<!/ <UTILITIES>  
{command}  
<PRINT>
```

where:

```
{command}:    VERSION
```

VERSION Example

Input (VERSION.LBL):

```
! UTILITIES  
VERSION  
PRINT
```

CHECKSUM Utility

This command reports the application checksum as a four character null-terminated ASCII string.

Format:

```
<!/ <UTILITIES>  
{command}  
<PRINT>
```

where:

```
{command}: CHECKSUM
```

CHECKSUM Example

Input (CHECKSUM.LBL):

```
! UTILITIES  
CHECKSUM  
PRINT
```

DEL Utility

The DEL command deletes the specified file.

Format:

```
<!/ <UTILITIES>  
{command} {name.ext}  
<PRINT>
```

where:

{command}: DEL

{name.ext}: Name of file to be deleted. Note: DEL *.* may be used to globally delete all files.

DIR Utility

The DIR command sends the file directory to a host.

Format:

```
<!> <UTILITIES>  
{command}  
<PRINT>
```

where:

{command}: DIR

DEFINE-FILE (DF) Utility

The DF command defines a file name for a file to be loaded into the printer. If a file with the same name already exists in the printer, it will be overwritten with the new file. The contents of the file must contain ASCII characters. To transfer binary files to the printer, use the utility provided in the Label Vista application.

Format:

```
<!/> {command} {filename.ext}  
{data}  
{terminator}
```

where:

{command}: DF

{filename.ext}: Name of file to be created.

{data}: The contents of the file. The file must be ASCII and cannot contain any *{terminator}* keyword.

{terminator}: Choose from the following:

PRINT: If the PRINT terminator is used, it is also written to the file.

END: If the END terminator is used, it is not written to the file.

DEFINE-FILE Example

Input (DF.LBL):

```
! DF AUTOEXEC.BAT
! UTILITIES
SETFF 200 20
PRINT
```

In this example the file AUTOEXEC.BAT is created in the printer flash file system. The file contents are:

```
! UTILITIES
SETFF 200 20
PRINT
```

Note: Every time a file is created on the printer using the "! DEFINE-FORMAT...", "! DF..." or the Visual Label Utility application, for example, the file information is written to flash memory. Unlike RAM, flash memory does not require battery for retaining data, and is immune to data corruption due to static discharge. Although flash memory is superior to RAM for safe guarding file contents, it is limited to an average of 10,000 write cycles (i.e. file creations). For this reason, the user should exercise the file creation commands such that the stated limit is not exceeded.

TYPE Utility

The TYPE command allows you to read a text file by sending it from the printer to a host.

Format:

```
<!/ <UTILITIES>  
{command} {name.ext}  
<PRINT>
```

where:

{command}: TYPE

{name.ext}: Name of text file to be sent to host.

BAUD Utility

The BAUD command enables you to set the printer serial port baud rate. Note: this command will take effect immediately and the requested baud rate will remain in effect when the printer is powered down.

Format:

```
<!/ <UTILITIES>  
{command} {baud}  
<PRINT>
```

Note that <PRINT> must be sent at the new baud rate

where:

{command}: BAUD

{baud}: Choose from the following:

1200
4800
9600
19200
38400
57600
115200

BAUD Example

Input (BAUD.LBL):

```
! UTILITIES  
BAUD 19200  
PRINT
```

COUNTRY / CODE-PAGE Utility

The COUNTRY utility command substitutes the appropriate character set for the specified country. See Section 8, page 22 for more information on the COUNTRY command.

Format:

```
<!/ <UTILITIES>  
{command} {name}  
<PRINT>
```

where:

{command}: COUNTRY

{name}: Choose from the following:

- USA
- GERMANY
- FRANCE
- SWEDEN
- SPAIN
- NORWAY
- CHINA (double byte encoding)
- ITALY
- CP850
- UK
- BIG5 (Traditional Chinese; double byte encoding)
- JAPAN-S (Simplified Japanese fonts; double byte encoding)

COUNTRY / CODE-PAGE Utility Example

Input (COUNTRY1.LBL):

```
! UTILITIES
; Tell the printer to use font 4 size 0
; for line printer mode with 5 millime-
ters
; line spacing
IN-MILLIMETERS
SETLP 4 0 5
COUNTRY USA
PRINT
```

```
This is text with
Country set to
USA
#$_[\]^`{|}~
```

```
! UTILITIES
COUNTRY ITALY
PRINT
```

```
This is text with
Country set to
ITALY
#$_[\]^`{|}~
```

Output:

```
This is text with
Country set to
USA
#$_[\]^`{|}~
```

```
This is text with
Country set to
ITALY
£$§°çé^`ù`à`ò`è`
```

Note: The printer must be configured with fonts that contain the extended character sets used in the selected country.

ANNOUNCE Utility

The ANNOUNCE command is used to activate pre-programmed sounds in the printer. A space character is required between each code. This command will be ignored by printers that are not equipped with a speaker and voice circuit.

Format:

```
<!> <UTILITIES>  
{command} {message}  
<PRINT>
```

where:

{command}: ANNOUNCE

{message}: Choose from the following:

<u>Code:</u>	<u>Spoken Messages:</u>
' '	pauses between sounds
'.'	"point"
'0'	"zero"
'1'	"one"
'2'	"two"
'3'	"three"
'4'	"four"
'5'	"five"
'6'	"six"
'7'	"seven"
'8'	"€"
'9'	"ı"
'^'	"version"
'{'	"go to aisle"
' '	"latch is open"
'}'	"battery is low"
'~'	"out of paper"

ANNOUNCE Utility Example

Input (ANNOUNCE.LBL):

```
! UTILITIES  
ANNOUNCE 1 2 . 2 5  
PRINT
```

Output:

The speaker will play the message "one two point two five."

TIMEOUT Utility

The TIMEOUT command allows you to set the time the printer will remain on without receiving data. If no data is received after the specified timeout, the printer will turn itself off to save energy and preserve battery life. You can disable the timeout feature by setting the timeout value to 0.

Format:

```
<!/ <UTILITIES>  
{command} {time}  
<PRINT>
```

where:

{command}: TIMEOUT

{time}: Time in 1/8 seconds of inactivity before printer will turn itself off.

TIMEOUT Utility Example

```
Input (TIMEOUT.LBL):
```

```
! UTILITIES  
TIMEOUT 960  
PRINT
```

This example sets the printer to turn off after 2 minutes of inactivity (120 seconds X 8 = 960).

BEEP Command

This command instructs the printer to sound the beeper for a given time length. Printers not equipped with a beeper will ignore this command.

Format:

{command} {beep_length}

Where:

{command}: BEEP

{beep_length}: Duration of beep, specified in
.125 (1/8th) second increments.

BEEP Command Example

This example instructs the printer to beep for two seconds (16 x .125 seconds = 2 seconds)

```
Input (BEEP.LBL):
```

```
! UTILITIES  
BEEP 16  
PRINT
```

ON-LOW-BATTERY Command

This command can be issued to instruct the printer as to what action to take when the battery voltage falls below the level set by the “low battery shut-down” setting.

format: {command} {options}

where: {command}: OLB

{options}: Choose from the following:

ALERT: The printer will transmit any message included between quote marks out the serial port.

ALARM: Sounds the printer’s beeper in 1/8 second increments. Valid range is ?-?. Printers not equipped with a beeper will ignore this option.

ON-LOW-BATTERY Command Example

This example instructs the printer to transmit the message “LOW BATTERY ALERT!” and sound the beeper for 5 seconds. (1/8 second x 40).

Input :

```
!UTILITIES OLB ALERT “LOW BATTERY ALERT!” ALARM  
40
```

LT Command

This command specifies the command line terminator character(s). The default terminator characters are CR/LF or LF. The printer can be programmed to accept a different character sequence to terminate command lines. This command does not apply to data sent to the printer when it is in line print mode.

Format

{command} {mode}

Where:

{command}: LT

{mode}: Choose from the following.

CR: Carriage-return (0x0D) character is the line terminator.

LF: Line-feed (0x0A) character is the line terminator.

CR-LF: Carriage-return/line-feed (0x0D 0x0A) characters are the line terminator.

CR-X-LF: Line terminator is a carriage-return (0x0D) followed by any number of characters followed by the line-feed (0x0A) character. Characters found between the carriage-return and line-feed characters are discarded.

LT Command Examples

Set the printer to require line-feeds only as a terminating character.

```
! UTILITIES LT LF PRINT
```

Set the printer to ignore any characters found between a carriage return character and a line-feed character.

```
! UTILITIES LT CR-X-LF PRINT
```

SET-TIME Utility

This command sets the time in the real time clock module. Time should be a valid time and be given in the specified format. This command will be ignored by printers that are not equipped with a real time clock module.

Format:

```
<!> <UTILITIES>  
{command} {time-stamp}  
<PRINT>
```

where:

```
{command}:          SET-TIME  
  
time-stamp}:      hh:mm:ss  
  
hh = hours (00 – 23)  
mm = minutes (00 – 59)  
ss = seconds (00 – 59)
```

GET-TIME Utility

This command reports the current time, if valid, as an eight character null-terminated ASCII string. This command will be ignored by printers that are not equipped with a real time clock module.

Format:

<!> <UTILITIES>

{command}

<PRINT>

where:

{command}: GET-TIME

Printer output: hh:mm:ss\0

hh = hours (00 – 23)

mm = minutes (00 – 59)

ss = seconds (00 – 59)

\0 = null terminator (00H)

SET-DATE Utility

This command sets the date in the real time clock module. Date should be a valid date and be given in the specified format. This command will be ignored by printers that are not equipped with a real time clock module.

Format:

```
<!> <UTILITIES>  
{command} {date-stamp}  
<PRINT>
```

where:

{command}: SET-DATE

{date-stamp}:mm-dd-yyyy

mm = month (01 – 12)

dd = day (01 – 31)

yyyy = year (1990 – 2089)

GET-DATE Utility

This command reports the current date, if valid, as an eight character null-terminated ASCII string. This command will be ignored by printers that are not equipped with a real time clock module.

Format:

<!> <UTILITIES>

{command}

<PRINT>

where:

{command}: GET-DATE

Printer output: mm:dd:yyyy\0

mm = month (01 – 12)

dd = day (01 – 31)

yy = year (1990 – 2089)

\0 = null terminator (00H)

Printing a Time Stamp

To print a time stamp on a label, use any text command and insert

[!<TIME] in place of the text to be printed.

Example:

<pre>Input (TIME.LBL) ! 0 200 200 210 1 TEXT 4 0 0 100 !<TIME FORM PRINT</pre>
<pre>Output: 14:47:23</pre>

Printing a Date Stamp

To print a date stamp on a label, use any text command and insert

[!<DATE] in place of the text to be printed.

Example:

<p>Input (DATE.LBL)</p> <p>! 0 200 200 210 1 TEXT 4 0 0 100 !<DATE FORM PRINT</p>
<p>Output:</p> <p>02-24-1998</p>

Magnetic Card Reader (MCR) Command

This command can be used to configure and activate the Magnetic Card Reader (MCR). The MCR command will be ignored by printers not equipped with a Magnetic Card Reader.

The MCR command can be issued in a label file (! 0 200 ... PRINT), or in a utilities command session (! UTILITIES ... PRINT). This command activates the MCR. When the printer is turned on, the MCR is not active by default until the MCR command is received. To make the MCR active on power-up, the MCR command can be issued from autoexec.bat or run.bat files.

The RXD LED of the printer will blink while the MCR is active. When the MCR times out or after a successful read (provided the MCR is not in MULTIPLE read mode,) the MCR will deactivate, thereby returning the RXD LED back to its normal state.

Format

{command} {time-out} {options}

Where:

{command}: MCR

{time-out}: time-out is the inactivity shut-down time, in 1/8th of a second. For example, time-out=80 for a 10-second inactivity time-out(10 * 8), or time-out=160 for a 20-second inactivity time-out(20 seconds * 8). The MCR timer starts ticking once the last option of MCR command is received by the printer. When MCR times out, it will not read a new card until a new MCR com-

mand is issued. The only exception to this rule is when MCR is in MULTIPLE read mode. See below for description of MULTIPLE read mode. A time-out of 0 will instruct the printer to never time-out, and wait for a successful read.

{options}: The options listed below can be specified in any order, and must be separated with spaces. The last option must be terminated with cr/lf (carriage-return / line-feed) characters. Options are accumulative, meaning that “MCR 10 ERRORS T1” and “MCR 40 T2” are equivalent to “MCR 40 ERRORS T1 T2”. The time-out field is not accumulative, and only the last specified time-out is used. Select from the following options:

Track Options:

T1 :Read Track 1. (can specify one or more tracks to read).

T2 :Read Track 2.

T3: Read Track 3. (Currently not supported)

Frequency Options:

MULTIPLE: Read multiple swipes. MCR will continue to read and report card swipes until the MCR times out. SINGLE read is the default mode.

SINGLE: Read and report one successful card swipe. No data will be reported

continued

if the MCR times out before a successful read. SINGLE read is the default read frequency mode.

Data Reporting Options

QUERY: Report MCR data when queried (In response to MCR-QUERY command, see MCR-QUERY.). By default, the printer will report MCR data when valid MCR data is decoded before the MCR times out.

Debugging Options

ECHO: The printer will print the MCR data by internally routing it to the line-printer module, forcing the data to be printed, as well as being transmitted to the host computer.

Track Data Transmit Options

PREFIX prefix: This option specifies the track data prefix. The printer defaults to no prefix. The PREFIX command should be followed by the data that needs to be sent from the printer to the host, up to 10 characters, and terminated with space or carriage-return/line-feed characters. An example of a typical prefix option is "PREFIX START:".

POSTFIX postfix: This option specifies the track data postfix. The printer defaults to no postfix. The POSTFIX command should be followed by the data

that needs to be sent from the printer to the host after all track data have been transmitted, up to 10 characters, and terminated with space or carriage-return/line-feed characters. An example of a typical postfix option is “POSTFIX END”.

DEL lr: Defines the track number delimiters, where “l” is the left delimiter character, and “r” is the right delimiter character. Default delimiters for the printer are “DEL T:”, meaning that the printer will transmit T, followed by the track number if track number reporting is specified via the TN option, and the ‘:’. The transmitted data will be, “T1:” or “T:”, or “T2:”, depending on the options selected.

DELAY nnn: This option specifies the inter-character delay of data sent from the printer to the host, in milliseconds. This command is typically used where the host computer can not collect data transmitted from the printer fast enough, resulting in missed characters. The default DELAY is 0. An example of the DELAY option is: “DELAY 15” which instructs the printer to observe a 15-millisecond delay before sending the next character data to the host.

TN: This option enables the reporting of track number between the delimiters (see “DEL lr” command). The printer will report the track number by default.

continued

NTN: This option disables the reporting of the track number, inserted between the delimiters. The printer enables track number reporting by default.

Error Reporting Options

ERRORS: This option turns error reporting on. Error reporting is turned off by default. The following is a list of the error messages (Please note that the following error messages will be transmitted only if error reporting is turned on, via the ERRORS option in the MCR command):

READ ERROR: This error is reported when the card could not be read due to errors such as parity check, LRC checksum, no end-sentinel, or invalid characters. It indicates that either: (1) the card is bad, or (2) the card was not swiped correctly. The printer will leave the MCR on and will continue to try to read future card swipe retries by the user until it times out or until a successful read, whichever occurs first.

CANCEL: This error is reported when a MCR-CAN command is received. This error message will confirm that the MCR is turned off.

TIME-OUT: This error is reported when the printer MCR times out before a successful read.

EPREFIX: This option is similar to the **PREFIX** command, but applies to error messages. Error messages, if error reporting is turned on, will be preceded by the specified eprefix. For example, “**EPREFIX ERROR:**” instructs the printer to prefix error messages with “**ERROR:**”. The default error prefix is “**Error:**”

MCR Command Examples

Example 1: This example sets the MCR in the printer for reading tracks one and two, with a timeout of 10 seconds (10 / 1/8th seconds = 80). The last option of the MCR command must be terminated with **cr/lf**.

```
! U1 MCR 80 T1 T2
```

Once the card is swiped successfully, the following is sent to host:

```
T1:B4000001234562^PUBLIC JR/JOHN Q.MR^9209101999999999  
<cr/lf>  
T2:4000001234562=9209101999999999<cr/lf>
```

If the printer times out or the card can not be read, the printer will not return anything to the host (because **ERRORS** option is not specified in this example).

Example 2: This example sets the MCR in the printer for reading tracks one and two, with a timeout of 10 seconds (10 / 1/8th seconds = 80). The **ECHO** command will instruct the printer to print the MCR data (in addition to sending that data to the host). The **ERRORS** option instructs the printer to report read errors, time-outs, or cancellations, if any. The last option of the MCR command must be terminated with **cr/lf**.

continued

```
! U1 MCR 80 ECHO T1 T2 ERRORS
```

Once the card is swiped successfully, the following is sent to host and printed:

```
T1:B4000001234562^PUBLIC JR/JOHN  
Q.MR^9209101999999999 <cr/lf>  
T2:4000001234562=9209101999999999<cr/lf>
```

If the printer times out before a successful read, it will send the following message to host and printed on the printer:

```
Error:T1:Time-out  
Error:T2:Time-out
```

Example 3: This example illustrates the PREFIX, EPREFIX, POSTFIX, and DEL (DELimiter) options:

```
! U1 MCR 80 ECHO T1 T2 ERRORS PREFIX START  
EPREFIX ERR POSTFIX END DEL ( )
```

Once the card is swiped successfully, the following is sent to host and printed:

```
START(1)B4000001234562^PUBLIC JR/JOHN  
Q.MR^9209101999999999END<cr/lf>  
START(2)4000001234562=9209101999999999END<cr/lf>
```

If the printer times out before a successful read, it will send the following message to host and printed on the printer:

```
ERR(1)Time-out<cr/lf>  
ERR(2)Time-out<cr/lf>
```

MCR-QUERY Command

The MCR can be put in a query mode by specifying the “QUERY” option in the MCR command, where it will report MCR data only when it is asked to via the MCR-

QUERY command. By default, the printer will report card swipe data immediately after a successful read.

The printer will not respond to MCR-QUERY if it does not have any data, either the track data or an error message. Multiple MCR-QUERY commands may be issued, keeping in mind that the response, or lack thereof, to the MCR-QUERY reflects the card swipe data at the moment MCR-QUERY is issued.

Format

{command}

Where:

{command}: MCR-QUERY

MCR-QUERY Command Example

In this example the printer is instructed to report the MCR read operation results.

```
! U1 MCR-QUERY
```

MCR-CAN Command

The MCR-CAN command will terminate the current MCR activity, and if error message reporting is enabled via the MCR command ERROR option, will transmit the “Cancel” error message to host.

Format

{command}

Where:

{command}: MCR-CAN

MCR-CAN Command Example

In this example the printer is instructed to deactivate the printer MCR and cancel any pending read operations.

```
! U1 MCR-CAN
```

S-CARD Command

The S-CARD command can be used to access the Towitoko Smartcard reader embedded within Zebra “SC” model mobile printers. The smart card library implements the T=1 protocol for ISO7816 compliant cards. This allows users to send ASCII commands to the printer and the printer will in turn forward this command to the smart card with the appropriate header and checksum information. The printer then returns the card’s response.

The S-CARD command set is only valid on “SC” model printers with a printer application at version 41h or above. The software version can be verified by performing a two-key reset as described in Section 1 of this manual. The number in the “Software:” listing on the second report must end in 41h or above (e.g. “Software: HTLK**41h**”)

Format

{Command } { Operation } { Options }

where:

{command}: S-CARD

The ‘Operation’ argument indicates how to access the reader. All options must be separated by a space unless stated otherwise. The options may appear in any order. The S-CARD command must be issued using the printer utility session command (!U1...) and terminated by a CRLF pair (0x0D0x0A).

Operation

The Operation command is a required element. An error will be returned if an invalid operation is specified (see ‘S-CARD Command Response’ for error codes). The possible Operation commands are:

CT_ATR: Each smart card has a unique ‘Answer To Reset’, or ATR. This ATR contains

continued

information relevant to data transmission and the card itself. This command/response has the following form:

Command:

```
! U1 S-CARD CT_ATR
```

Response:

```
<ACK><LENGTH><ATR DATA>
```

CT_DATA: This command is used to send a command to the smart card. The response from the card is returned. A command of this type has the following form:

```
<CT_DATA> <Length of command>  
<card command in ascii form>
```

Example:

```
! U1 S-CARD CT_DATA 10 8010000008
```

Description: CT_DATA: indicates the command is to go to the smart card.
10 = length of command
8010000008 = Command to go to the card in ascii form. This command is converted to binary and sent to the card.

Response for successful command:

```
<ACK><LENGTH><DATA><SW1><SW2>
```

Explanation of response:

<ACK> = Successfully send command to the card and received a response.

<LENGTH> = The response length. This length is for data only (i.e. SW1 and SW2 are not included in response length).

<DATA> = This is the response from the

continued

card (in binary form).

<SW1> = Status byte from card

<SW2> = Status byte from card

Note: See ISO-7816-3 for an explanation of SW1 and SW2

Response for an unsuccessful command:

<NAK><ERROR CODE>

See 'Error Codes' below for an explanation of possible error codes.

CT_CLOSE: This command will power down the reader and turn off the red LED on the smartcard module. This command should be used after communicating to the card with the CT_DATA command.

DEBUG-ON: Enables debug on the printer. This will cause some messages to print out as the printer configures itself for pass-through mode. The messages printed relate to port parameters for the internal communication port communicating with the Smartcard reader and a message will also print out when the printer has been taken out of pass-through mode. Once in 'pass-through' mode, no debug messages are printed.

Error Codes

Errors from the S-CARD command are of the following format:

<NAK><ERROR CODE>

Where any of the following are possible error codes:

<0x02> = Protocol not supported (card is not using T=1 protocol)

<0x10> = No card detected

continued

<0x11> = Invalid drive type (currently only the Towitoko CHIPDRIVE micro is supported)

<0x12> = Invalid operation

<0x16> = Invalid command length in S-CARD command

S-CARD COMMAND EXAMPLES

This section provides some examples for using the S-CARD command to communicate with the internal Smartcard reader from the 'External Terminal'.

Read card ATR

! U1 S-CARD CT_ATR

Response:

<ACK><0X0D>< 3B E3 00 FF 91 81 71 26 44 00
54 54 54>

Traceability command:

! U1 S-CARD CT_DATA 10 8010000008

Note: When the printer actually sends this command to the printer, it converts the command to binary, adds the appropriate T=1 header and computes the overall command checksum. Then the printer sends this command to the smart card.

Response:

<ACK><08>< C9 1C 92 AA 66 19 A0 00><90><00>

CT_CLOSE command

! U1 S-CARD CT_CLOSE

DENSO BHT COMMANDS

NOTE: All commands in this section are compatible with ACKNAK-IT v 6.1 or greater.

Zebra mobile printers can have an application downloaded which will support communications to the Denso Barcode Handy Terminal (BHT).

The different methods of communications between a BHT and a Zebra mobile printer are per the table below:

Connection/protocol type		Refer to	
Cable	IR	Autoexec.bat File	pg. no
Cable w/BHT		PROBHT.CBL	P10-52
	IR w/BHT	PROBHT.IR	P10-52
Cable w/BHT-IR		PROBHTIR.CBL	P10-53
	IR w/BHT-IR	PROBHTIR.IR	P10-53

Data is sent to the printer formatted as a BHT .DAT file. The printer will check for the “.DAT” filename extension. Since the format of data using this protocol is not always what the printer requires, there are several modes of operation that can be set within the printer to specify how record data fields delivered by the protocol are interpreted.

Setting the Data Format

If the default mode (strip trailing spaces then add CR/LF for each data field) is not desired, any of the operating modes can be set by loading an AUTOEXEC.BAT command file into the printer’s flash memory.

Note that any commands intended to modify the BHT operating modes must be placed between the SRF-ACCESS and the END-SRF-ACCESS command lines.

continued

Mode 1: (Default) Strip trailing spaces and add CR/LF
Each data field in a record has any trailing spaces stripped and a CR/LF (carriage return/line feed) pair added. The data field (stripped of trailing spaces and with an appended CR/LF pair) is then passed to the printer for processing. This is the default way to handle data sent to the printer.

Mode 2: Include all characters in each field (RAW)
The second mode accepts all characters that make up each data field. Using this method, any trailing spaces in a data field will be INCLUDED as data for the printer to process.

Mode 3: Use the first byte as a count of characters to send to the printer.
This mode is based on the first character of a data field being interpreted as a count of data bytes that follow. It is similar to a 'counted string' as found in the Pascal programming language String data type. In the 'counted string' mode, the number of bytes specified by the count will be transferred into the printer. The count byte's maximum value is limited to the data field size minus 1. Note that in this example the count byte is shown as ASCII, but would actually be sent as a binary number.

Mode 4: Strip trailing spaces
This mode eliminates trailing spaces in each data field of a record. Note that unlike Mode 1 no CR/LF pair is added to the data after stripping the trailing spaces. Refer to pgs. P10-44 thru P10-47 for examples using the BHT-MODE commands

continued

IR or Cable Interface Selection

The printers are normally self configuring for IR or cable data transmission. Plugging in the communications cable will disable the IR interface; removing the cable will make it active. This default method of interface selection can be overridden by means of a BHT-PROTOCOL command in an autoexec. bat file. (Refer to the examples at the end of this section on setting the mode for IR or cable data transmissions.) BHT-PROTOCOL CABLE enables BHT or BHT-IR protocol via cable. If the BHT-PROTOCOL CABLE command is *not* present, data is sent “raw” over the serial cable; if it is detected BHT-PROTOCOL BHT sends data in the BHT mode; BHT-PROTOCOL BHTIR sends data in the BHT-IR mode. Performing a two-key reset of the printer will return it to its normal, automatic selection mode. (Refer to pg. P1-2 in this manual for the reset procedure.)

BHT-BAUD Command

The printers support 9600 and 19200 BPS baud rates. The default baud rate for communication with Zebra mobile printers is 9600 BPS. Configuring a BHT baud rate will set both the IR and the cable transmit speeds to that rate. You must insure that both the printer and the BHT are set to the same baud rate. This can also be changed in an AUTOEXEC.BAT file with the BHT-BAUD <baud-rate> command. (Refer to the BHT-BAUD command example at the end of this section.)

Setting the Mode for IR Data Transmission

Autoexec.bat files can configure the printer for IR data transmission modes. The following notes apply:

- Unless specified otherwise with a BHT-PROTOCOL CABLE command, communication over a serial cable

continued

does not use the BHT or BHT-IR protocol. In this default (“raw”) mode, any Zebra mobile printer utility for reprogramming, adding or deleting files will be in effect.

- If the printer has been configured to include the BHT or BHT-IR protocol with the serial cable the following procedure may be used to force the printer to communicate “raw” (i.e. using no protocol) for the purposes of reprogramming, or the adding or deleting of files.
 1. Connect the printer to a host terminal loaded with the desired communications software.
 2. Turn the printer on by starting the terminal’s communications program.
 3. Turn the printer off, then, while holding the “Feed” key down, turn the printer back on.
 4. The printer will print a status report. When the printout is complete, the communications protocol will be in the “raw” mode.

(Refer to the BHT-MODE Commands examples at the end of this section.)

Configuring the BHT for IR transmission

The BHT must also be configured correctly to communicate with Zebra mobile printers using the BHT or BHT-IR protocol. All parameters that must be set are found in the BHT Set System → Communication menu area. The following notes apply:

- The pulse width for optical communications must be set to 1.63 μ S.
- The protocol is set to match the protocol in the printer. Default for the printer is BHT-IR unless

continued

- specified as BHT by an AUTOEXEC.BAT file.
- The baud rate (if the printer uses the default) is set to 9600 BPS
 - The Serial Number is set to ON.
 - Zebra mobile printers use a ID number of 9. You should avoid using this ID value for the terminal.
 - The Com port is set to OPTICAL.

BHT-IR File Transmission

Assume that a label file CIS.DAT has been loaded into the BHT. (Refer to pg. _ for details on loading a *.DAT file.) The steps to transmit this file via IR are as follows:

1. Depress the 1 / PW / SF keys all at once, then release. The SYSTEM MENU should be displayed. This menu has 6 options. This power on sequence must be performed every time to boot to the SYSTEM MENU. A regular power on (PW key) will boot into the BHT application.
2. Select option 3:UPLOAD. Press the ENT key. The UPLOAD menu should now be displayed. Select option 1:DRIVE A. Press the ENT key. Use the arrow keys, F5, and F6, to scroll through the menu options to the desired file. (CIS.DAT in our example) When CIS.DAT is highlighted, press the ENT key.
3. The IR on the BHT should be pointed towards the IR window on the printer. The transfer of data will power on the printer if it is not already on. When file transfer is complete, ** Completed ** is displayed for the user and a beep sounds. The file will then print. Press the C key to exit this screen.
4. Continue to press the C key to exit back 1 menu at a

continued

time (if desired). The SYSTEM MENU is the top-level menu.

5. After a successful UPLOAD, the CIS.DAT file must be re-selected again to transfer to the printer.

NOTES: The arrow keys or a numeric keypress can be used to select a menu option. The arrow keys are F5 through F8. A press of the ENT key usually needs to accompany the option selection. Hold down the PW key for 1 – 2 seconds to turn the BHT off, or let it power down automatically.

Communication errors can occur infrequently during BHT-IR transmission. If a transmission is unsuccessful, the data should be re-sent.

Configuring the BHT for Cable Transmission

The BHT can also be configured for cable communications with Zebra mobile printers using either the BHT or the BHT-IR protocol. All parameters that must be set are found in the BHT Set System \AE Communication menu option. The following notes apply:

- The protocol type is set to BHT or BHT-IR protocol. Printer default is BHT-IR
- The SET CONNECTOR menu options:
 1. The TRANSMIT SPEED (if the printer uses the default) is set to 9600 BPS
 2. The PARITY BIT is set to NONE
 3. The DATA BIT is set to 8 BITS
 4. The STOP BIT is set to 1 BIT
 5. The Serial Number is set to ON
 6. The Horizontal Parity is set to ON
- The COM PORT is set to IFC (on the BHT-5000 set COM DEFAULT to CONNECTOR)

continued

Loading a .DAT file into the BHT

Zebra mobile printers will only print files with the .DAT extension sent from the BHT. The following example file CIS.DAT contains a label file that can be loaded from a PC into the BHT via a serial cable using the TU3.EXE utility provided by DENSO. The file can then be sent to a Zebra mobile printer to produce a label. Files with a .DAT extension contain records composed of one or more record fields. For CIS.DAT, each record will be specified as having only one field with a width of 40 bytes. The 40 byte width was chosen because no single line in the example CIS.DAT file exceeds 40 bytes. The resulting records transferred to the BHT will each contain a single field 40 bytes wide. The BHT and BHT-IR protocol will add space characters as needed to any field containing less than 40 bytes. Thus the CIS.DAT file contains 24 lines that will be interpreted as 24 records containing a single field of 40 bytes.

Note that while the example uses the TU3.EXE utility to download the file from a PC, these files could also be created under control of an application program executing directly on the BHT.

The command line that will transfer this file into the BHT is: `TU3 +MPC +B9600 CIS.DAT +F40`

The BHT will now contain the file CIS.DAT.

continued

Sending The Example Label File to the Printer

Zebra mobile printers with the BHT application will print files with the .DAT extension. As noted before, the default action of the printer when a record is received is to strip all trailing spaces from all record fields, then append a carriage return/line feed pair to the data. Using this default, the trailing spaces in every field of the example CIS.DAT file will be stripped, and a CR/LF pair will be added.

Interrupted Transmissions

If a transmission from the terminal to the printer is interrupted, the user should wait at least five seconds before attempting another transmission. During this delay, the printer will discard any partial data received from the interrupted transmission and reset itself to receive a new transmission.

continued

Example .dat File

Input (CIS.DAT)

```
! 0 200 200 581 1
;MEDIA P/N LD-E9QT7S
LABEL
CONTRAST 0
TONE 0
SPEED 3
PAGE-WIDTH 240
BAR-SENSE
;// PAGE 0000000002400600
;// TEXT 0 1 3 560 DEPT 34
TEXT90 4 3 36 288 $22.88
TEXT90 5 2 163 273 SWEATSHIRT
VBARCODE UPCA 2 1 45 139 576 04364503284
TEXT90 7 0 191 511 043645032841
TEXT90 5 0 4 524 COMPARE AT
TEXT90 4 0 30 508 $ 30.00
TEXT90 5 0 115 575 ZD-180-KL
TEXT90 5 2 119 269 ALL COTTON
TEXT90 7 0 114 389 01/17/98
TEXT90 0 0 208 173 EA00-732-00560
TEXT90 5 0 82 519 ELSEWHERE
BOX 189 358 217 527 1
FORM
PRINT
```

Output:

COMPARE AT
\$ 30.00
ELSEWHERE

ZD-180-KL 01/17/98

043645032841

\$22.88
ALL COTTON
SWEATSHIRT

EMER-732-00560

SRF-ACCESS and END-SRF-ACCESS Commands

Commands intended to modify the BHT operating modes must be placed between the SRF-ACCESS and the END-SRF-ACCESS command lines.

SRF- and END-SRF-ACCESS Command Example

This autoexec.bat file uses the SRF-ACCESS and END-SRF-ACCESS command pair to establish BHT communication via the BHT-CABLE protocol.

```
Input: PROBHT.CBL
```

```
! DF AUTOEXEC.BAT
! UTILITIES
SRF-ACCESS
BHT-PROTOCOL BHT
BHT-PROTOCOL CABLE
BHT-BAUD 19200
BHT-MODE STRIP-ADD-CRLF
END-SRF-ACCESS
PRINT
```

continued

BHT-BAUD Command

This command will set both the IR and the cable transmit speeds. You must insure that both the printer and the BHT are set to this same baud rate. This can also be changed in an AUTOEXEC.BAT file with the BHT-BAUD <baud-rate> command.

Format:

{command} {baud rate}

where:

{command}: BHT-BAUD

{baud rate}: 9600,19200. Default value for Zebra mobile printers is 9600 BPS.

BHT-BAUD Command Example

The following example sets BHT-IR communications to use a baud rate of 19200 BPS and to strip spaces from received data fields.

```
! DF AUTOEXEC.BAT
! UTILITIES
SRF-ACCESS
BHT-MODE STRIP-SPACES
BHT-BAUD 19200
END-SRF-ACCESS
PRINT
```

BHT MODE Commands

This command sets one of several modes of operation to specify how record data fields delivered by the BHT protocol are interpreted.

Format:

{command} {mode}

where:

{command}: BHT-MODE

{mode}: STRIP-ADD-CRLF

Each data field in a record has any trailing spaces stripped and a CR/LF (carriage return/line feed) pair added. The data field (stripped of trailing spaces and with an appended CR/LF pair) is then passed to the printer for processing. This is the default way to handle data sent to the printer.

RAW

The RAW mode accepts all characters that make up each data field. Using this method, any trailing spaces in a data field will be INCLUDED as data for the printer to process.

COUNTED STRING

This mode is based on the first character of a data field being interpreted as a count of data bytes that follow. In the 'counted string' mode, the number of bytes specified by the count will be transferred into the printer. The count byte's maximum value is limited to the data field size minus 1.

STRIP-SPACES

This mode eliminates trailing spaces in

continued

each data field of a record. Note that unlike the STRIP-ADD-CRLF mode, no CR/LF pair is added to the data after stripping the trailing spaces.

BHT MODE Command Examples

In the following examples a record is defined to be made up of 3 data fields. Fields 1, 2 and 3 are 10, 8 and 20 bytes long, respectively. The "^" character indicates a space character. Other combinations of fields and field lengths can be used as long as they conform with the BHT protocol's data file record field formats.

Example 1: Strip Spaces and Add CR/LF:

```
Input: ADDCRLF.BAT

! DF autoexec.bat
! UTILITIES
SRF-ACCESS
BHT-MODE STRIP-ADD-CRLF
END-SRF-ACCESS
PRINT
```

Output:

Data Record:

```
|----10----|---8---|-----20-----
|
Comtec^^^^ ^Info^^^ ^Systems^^^^^^^^^^^^^^
```

Data Sent to printer:

```
|Comtec<CR><LF>^Info<CR><LF>^Systems<CR><LF>|
```

continued

BHT MODE Command Examples (continued)

Example 2: Send Raw Data

```
Input: SENDRAW.BAT
```

```
! DF autoexec.bat
! UTILITIES
SRF-ACCESS
BHT-MODE RAW
END-SRF-ACCESS
PRINT
```

Output:

Data Record:

```
|----10----|---8---|-----20-----
|
Comtec^^^^ ^Info^^ ^Systems^^^^^^^^^^^^^^
```

Data Sent to printer:

```
Comtec^^^^ ^Info^^ ^Systems^^^^^^^^^^^^^^
```

Example 3: Counted String

```
Input: COUNTED.BAT
```

```
! DF autoexec.bat
! UTILITIES
SRF-ACCESS
BHT-MODE COUNTED-STRING
END-SRF-ACCESS
PRINT
```

Data Record:

```
|----10----|---8---|-----20-----
|
6Comtec^^^ 6^Info^^ 7Systems^^^^^^^^^^^^^^
```

Data Sent to printer:

```
Comtec^Info^Systems
```

continued

BHT MODE Command Examples (continued)

Example4: Strip Spaces

```
Input: SSPACES.BAT

! DF autoexec.bat
! UTILITIES
SRF-ACCESS
BHT-MODE STRIP-SPACES
END-SRF-ACCESS
```

PRINT

Output

Data Record

```
|----10----|---8---|-----20-----
|
Comtec^^^^ ^Info^^ ^Systems^^^^^^^^^^^^^^
```

Data Sent to printer

```
|Comtec^Info^Systems|
```

continued

BHT PROTOCOL Command

This command placed in an autoexec. bat file overrides the default method of communication.

BHT-PROTOCOL CABLE enables BHT or BHT-IR protocol via cable. If the BHT-PROTOCOL CABLE command is *not* present, data is sent "raw" over the serial cable, if it is detected the BHT-PROTOCOL BHT command sends data in the BHT mode; BHT-PROTOCOL BHTIR sends data in the BHT-IR mode.

Format: {Command} {mode}

where:

{Command}: BHT-PROTOCOL

{mode}: BHT

This mode establishes that data will be sent in BHT protocol mode

CABLE

This mode enables BHT or BHT-IR protocol via cable. If the BHT-PROTOCOL CABLE command is detected the BHT-PROTOCOL BHT command sends data in the BHT mode

BHTIR

Sends data in the BHT-IR mode.

continued

BHT PROTOCOL Command Examples

Example: Cable printing with BHT protocol

Using Cable with BHT protocol

```
Input: PROBHT.CBL  
  
! DF AUTOEXEC.BAT  
! UTILITIES  
SRF-ACCESS  
BHT-PROTOCOL BHT  
BHT-PROTOCOL CABLE  
BHT-BAUD 19200  
BHT-MODE STRIP-ADD-CRLF  
END-SRF-ACCESS  
PRINT
```

EXAMPLE: IR printing with BHT protocol

Print using IR communications with BHT protocol

```
INPUT: PROBHT.IR  
  
! DF AUTOEXEC.BAT  
! UTILITIES  
SRF-ACCESS  
BHT-BAUD 19200  
BHT-PROTOCOL BHT  
BHT-MODE STRIP-ADD-CRLF  
END-SRF-ACCESS
```

continued

BHT PROTOCOL Command Examples (continued)

Example: Cable printing with BHT-IR protocol

Print using cable BHT-IR protocol

```
Input: PROBHTIR.CBL  
  
! DF AUTOEXEC.BAT  
! UTILITIES  
SRF-ACCESS  
BHT-BAUD 19200  
BHT-PROTOCOL BHTIR  
BHT-PROTOCOL CABLE  
BHT-MODE STRIP-ADD-CRLF  
END-SRF-ACCESS  
PRINT
```

Example: IR printing with BHT-IR protocol

Print using IR with BHT-IR protocol

```
Input: PROBHTIR.IR  
  
! DF AUTOEXEC.BAT  
! UTILITIES  
SRF-ACCESS  
BHT-BAUD 19200  
BHT-PROTOCOL BHTIR  
BHT-MODE STRIP-ADD-CRLF  
END-SRF-ACCESS  
PRINT
```

PRINTER ESCAPE COMMANDS

SET AND READ CODE COMMAND

Printer command sessions normally start with the '!' character. When the printer is used in Generic Text Mode (or Line-Print Mode) and if the user expects to print the '!' character in that mode, then the CCL code must be changed. This is done via the Redefine CCL Code command.

Send the following sequence to redefine the code:

Set CCL Code: ESC (0x1b) '}' (0x7D) 'W' (0x57) '!' (0x31) <new code>
(SETCCL.LBL)

Where {new CCL code} is a one-byte character representing the new CCL code.

Once the CCL Code is changed, all CCL sessions should be started with the new CCL code. For example, if CCL code is changed to '~', then instead of issuing a '! UTILITIES' command to the printer, '~ UTILITIES' should be issued.

The printer will retain the new CCL code for as long as it remains powered. If the printer is powered off and back on again, it will revert back to normal operations and will expect '!' as the CCL code.

Send the following sequence to read the CCL code:

Read CCL Code: ESC (0x1b) '}' (0x7D) 'R' (0x52) '!' (0x31)
(READCCL.LBL)

After the above command is issued, the printer will return the one-character CCL code.

PRINTER ESCAPE COMMANDS FORMAT

Format:

{escape} {command} [/parameters]

where:

{escape}: The ESC character (0x1b).

{command}: Choose from the escape commands in this section.

[/parameters]: Parameters for the escape commands.

Note: The escape commands should not be used while in a control/utility session ("! UTILITIES... PRINT" OR "! 0... PRINT").

STATUS/INFORMATION

Get Printer Status ESC (0x1b) 'h' (0x68)

This command requests a status byte from the printer. If one is returned, it indicates that the printer is operational and has finished processing the previous label. It should be called before loading or printing a label in order to make sure that the host software is synchronized with the printer. If bit 3 of the status byte is high, it indicates that the battery is low. If bit 4 is high, it indicates that the printer has been powered on and reset (see the Reset Status function). This command requests a status byte from the printer with the following format:

<u>Bit</u>	<u>Description</u>
4	Printer reset (0=reset cleared, 1=printer reset)
3	Battery status (0=voltage OK, 1=low battery)
2	Latch status (0=latch closed, 1=latch open)
1	Paper status (0=paper present, 1= out of paper)
0	Printer status (0=printer ready, 1=printer busy)

Acknowledge Printer Reset ESC (0x1b) 'N' (0x4e)

This command clears the reset bit that is set on power-up and reported by the 'get printer status' function. The reset information returned by ESC 'h' may be used by the host to perform its printer power-up initializations, such as form-feeding. Once the host completes its initialization of the printer, it may call this function to tell the printer to clear its reset bit.

STATUS/INFORMATION (continued)

Get Printer Information (GPI.LBL)

ESC (0x1b) 'v' (0x76)

This command instructs the printer to return a null-terminated string containing its model number, firm-ware revision and serial number. In practice, a search for the NUL character should be used, since the length of the string returned may change.

Get Extended Printer Status ESC(0x1b) 'i' (0x69)

This command requests the extended status byte from the printer. Printer program versions 24 and higher respond to this command. The extended status byte returned from the printer is in the following format:

Bit Description

- 7 Ribbon status: 0=ribbon detected, 1=no ribbon detected
- 6 Paper supply status: 0=paper supply is OK
1=paper supply is low
- 5 Presentation (peeler) sensor: 0=last label removed, 1=last label not removed yet
- 4 Reserved
- 3 Reserved
- 2 Reserved
- 1 Reserved
- 0 Reserved

Note: Mask all reserved bits when reading status.

USER LABEL COUNT

Get User Label Count (GULC.LBL)

ESC (0x1b) 'J' (0x4a) 'R' (0x52) 'U' (0x55)

This command requests the current user label count from the printer. The response consists of two bytes, most significant byte first. This count represents the total number of labels printed since the last time the count was reset to zero.

Reset User Label Count (RULC.LBL)

ESC (0x1b) 'J' (0x4a) 'W' (0x57) 'a' (0x61) 'c' (0x63) 'c' (0x63) 'N' (0x4e) 'V' (0x56) 'M' (0x4d) 'U' (0x55)

This command instructs the printer to clear its user label count to zero.

POWER OFF COMMAND

Off Command (OFF.LBL)

ESC (0x1b) 'p' (0x70)

This function instructs the printer to shut off. This function can be used instead of lowering DTR causing the printer to shut down.

WIRELESS NETWORK PRINTERS

Introduction

Zebra Cameo 3N and Encore 3N Network Printers are equipped with a WLAN (Wireless Local Area Network) card. Network printers allow wireless communication as a node within a local area network, and its wireless capabilities allow communications from any point within the LAN's perimeter.

The following section details commands used with Network Printers to configure various characteristics and to interrogate the printer for its network settings.

Note: If you are using a WLAN enabled QL series printer, you should use the "get, set, do" parameters detailed in Section 14 rather than the LAN command detailed below.

Network Printer Safety Considerations

 **WARNING:** Use of the Network Printers will result in exposure to Radio Frequency radiation. To conform to FCC RF exposure requirements these printers must be used only in the intended orientation and in the intended manner.

Refer to the User's Manual for the Network Printer in use for more specific safety instructions. In all cases, avoid prolonged exposure closer than 5 cm. (2") to the radiating area around this unit's antenna.

LAN Command

Format:

LAN { *Operation* } { *Options* } ... { *Operation* } { *Options* }

The LAN command can be used to interrogate and configure the Wireless LAN (WLAN) card in a Zebra Network Printer. The entire LAN command must be terminated by a CRLF pair (0x0D0x0A).

{Operation} is a required element. An error will be returned if an invalid operation is specified (see 'LAN Command Response' for error codes). Any desired number of Operations can be entered after the LAN command. The possible Operations are:

IPADDR – This operation allows manual specification of the printer's TCP/IP address. (See the DHCP operation for a description of automatic address assignment.) The option to this operation must be a valid TCP/IP address in the typical dot notation. i.e., a set of four decimal numbers between 0 and 255 separated by dots. E.g., 100.150.200.150 is a valid address. This value will most likely need to be assigned by the administrator of the network the printer will operate on. If an invalid address is specified, this operation has no effect other than to print an error message.

Syntax: IPADDR {IP-Address}

Where {IP-Address} = nnn.nnn.nnn.nnn. Each nnn may range from 0 to 255.

Example: ! U1 LAN IPADDR 90.80.70.60

GATEWAY-IPADDR- This command can be used to set the gateway IP address of the printer. (Available in printer application versions 30A and higher.)

Syntax: GATEWAY-IPADDR {IP-Address}

Where {address} is the dotted decimal representation of the address. For example, 10.14.2.25

Example: ! U1 LAN GATEWAY-IPADDR 12.15.10.3

REMOTE-IPADDR- This command can be used to set the remote IP address of the printer. (Available in printer application versions 30A and higher.)

Syntax: REMOTE-IPADDR {IP-Address}

Where {address} is the dotted decimal representation of the address. For example, 10.14.2.25

Example: ! U1 LAN REMOTE-IPADDR 12.15.10.3

SUBMASK- This command can be used to set the subset mask of the printer. (Available in printer application versions 30A and higher.)

Syntax: SUBMASK {IP-Address}

Where {address} is the dotted decimal representation of the subset mask. For example, 10.14.2.25

Example: ! U1 LAN SUBMASK 12.15.10.3

SSID- This operation allows the assignment of an RF SSID (Radio Frequency System Set ID). This ID allows several RF networks to operate independently in the same area without interference. The printer must have the same SSID as the RF Access Point to which it is supposed to link. The option for this operation may be any string up to 32 characters long.

Syntax: SSID {SSID string}

Where {SSID string} = 32 characters.

Example: ! U1 LAN SSID ZebraNet

MODE – This operation sets the operating mode of the printer. The two options are LPD and TCP. LPD is the standard printer protocol used by Unix and available for Windows NT. TCP affords the ability to allow bare sends using only the TCP protocol.

Syntax: MODE {option}

Where {option} = LPD or TCP.

Example: ! U1 LAN MODE LPD

GET-STATUS – This operation causes the printer to report its current WLAN status. The two options are PRINT and REPLY. If PRINT is used, the status dump is printed. If REPLY is used, the status dump is sent out over the CABLE. The status report is of the

following form:

```
LAN Status report:  
ipAdr = nnn.nnn.nnn.nnn  
userName = {the user name}  
fwVersion = {LAN firmware version}  
swVersion = {LAN software version}  
MAC addr = hh:hh:hh:hh:hh:hh  
associated = {link state}
```

Where:

nnn.nnn.nnn.nnn = a typical TCP/IP address.

{the user name} = a descriptive username set in the radio.

{LAN firmware version} = a descriptive firmware version set in the radio.

{LAN software version} = a descriptive software version set in the radio.

hh:hh:hh:hh:hh:hh = the IEEE network address of the LAN card.

{link state} = YES or NO

Syntax: GET-STATUS *{option}*

Where *{option}* = PRINT or REPLY.

Example: !U1 LAN GET-STATUS PRINT

GET-CONFIG – This operation causes the printer to report its current WLAN configuration. The two options are PRINT and REPLY. If PRINT is used, the configuration dump is printed. If REPLY is used, the configuration dump is sent out over the CABLE. The configuration report is of the following form:

```
LAN Config report:  
ipAdr = nnn.nnn.nnn.nnn  
powerMode = {power mode state}  
quiet = {quiet state}  
protocol = {protocol selected}  
essID = {SSID string}  
DHCP = {DHCP state}  
DHCP_SAVE = {DHCP_SAVE state}
```

Where:

nnn.nnn.nnn.nnn = a typical TCP/IP address.

{power mode state} = SAVE or FULL.

{quiet state} = YES or NO. YES means the radio only transmits normal data, NO means the radio transmits link status information on power up and status change.

{protocol selected} = LPD or TCP.

{SSID string} = the System Set ID string.

{DHCP state} = ON or OFF

{DHCP_SAVE state} = ON or OFF

Syntax: GET-CONFIG *{option}*

Where *{option}* = PRINT or REPLY.

Example: ! U1 LAN GET-CONFIG PRINT

SOFT_RESET – This operation resets the WLAN card. If the application determines that the WLAN card is not responding (e.g., if a GET_STATUS query goes unanswered), it may try to reset the card. SOFT_RESET should be tried first, and if it fails then RESET should be used.

Example: ! U1 LAN SOFT_RESET

RESET – This operation performs a “hard” reset of the WLAN card. If the application determines that the WLAN card is not responding (e.g., if a GET_STATUS query goes unanswered), it may try to reset the card. The SOFT_RESET command should be tried first, and if that fails then RESET should be used

Example: ! U1 LAN RESET

DHCP – This operation allows for control over setting of the WLAN card’s IP address. The options for this operation are enabled (ON) or disabled (OFF). If

DHCP is enabled, the WLAN card will attempt to obtain an IP address from a DHCP server. If DHCP is disabled, the WLAN card will use the IP address programmed into its non-volatile storage.

Syntax: DHCP *{option}*

Where *{option}* = ON or OFF

Example: ! U1 LAN DHCP ON

DHCP-SAVE – This operation allows for control of the storing of addresses obtained by DHCP. If ON, a new address obtained from DHCP will be stored. If OFF, the new address will be used for this session only, leaving the previously stored address unchanged.

Syntax: DHCP-SAVE *{option}*

Where *{option}* = ON or OFF

Example: ! U1 LAN DHCP-SAVE ON

DHCP-TIMEOUT – This operation allows for control of number of times the DHCP client will attempt to obtain an address from the DHCP server. The argument is the number of times the client will make a request before giving up. The client can be told to never give up by making the argument 0.

Syntax: DHCP-TIMEOUT {0 – 15}

Example: ! U1 LAN DHCP-TIMEOUT 5

PORT – This operation allows for setting of the TCP port that the printer will listen on while in TCP mode.

Syntax: PORT {PortNumber}

Example: ! U1 LAN PORT 515

Setting the IP Address for Network Printers

1. Create the following document in a text editor such as Notepad, replacing (192.0.11.195) with your Network Printer's address, and (ZebraNet) with the SSID of your RF Access Point. It may be necessary to obtain this information from your network administrator:

! UTILITIES

```
LAN IPADDR 192.0.11.195 SSID ZebraNet MODE LPD  
PRINT
```

Insure each line, including the last, is terminated with <CRLF>. Save the file in a convenient location.

2. Using a serial communications cable (p/n BL11757-000), connect the printer to the serial port of a PC loaded with the Label Vista™ program. Open Label Vista and select the "Diagnostic Send" utility under the Printer menu.
3. Use the "Browse" button to navigate to the file you created in step 1 and click on the "Send" button. The file will be sent to the printer, and the dialog box will indicate the download progress.

Once the IP address has been downloaded successfully, it will stay resident in the printer's memory until a new IP address is sent. The IP address can be verified by performing a "2 key reset" on the printer.

The "2 key reset" is initiated by the following key sequence:

1. Press the "FEED" key,
2. While still holding down the "FEED" key, press and release the "ON/OFF" key (Cameo 3N) or the "On" key (Encore 3N).
3. Keep the "FEED" key depressed until printing starts. The printer will produce a line of interlocking "x" characters to insure all elements of the print head are working, and then print out a status report.

The resulting printout should include a Wireless Communications section. You should verify that the following lines are included, with your IP address and SSID:

```
ipAdr = (your IP address)
associated = YES
protocol = LPD
essID = (Your SSID)
DHCP = OFF
```

If there is no Wireless Communications section or the parameter values do not match what is expected, please refer to the Network Printer Troubleshooting discussion at the end of this section.

Details of this method of setting the IP address are covered earlier in this section in the discussions of the IPADDR, SSID and MODE operations.

LAN Command Response

If an operation unsupported by the LAN command is given, the printer will generate the following message:

```
***Invalid LAN option {operation}
```

where {operation} is the invalid operation

If an operation with an option unsupported by the LAN command is given, the printer will print the following message:

```
Illegal{operation}option {option}
```

where {option} is the invalid option.

Network Printer Troubleshooting

If the printer does not behave as described in this section, please take the following diagnostic steps:

1. Perform a 2 key reset on the printer. I.e., turn the printer off, depress and hold the FEED key, press the POWER key, and then release the FEED key. The printer will produce a line of interlocking "x" characters to insure all elements of the print head are working, and then print out a status report. Refer to next page for an annotated sample of a status report.
2. Under the status report's Program heading, the software should have a label similar to HTLANxxx. If not, the LAN application is not loaded on this printer and LAN operation is not supported. Call Zebra tech support.
3. Under the RF LAN INFORMATION section, if you see: "Could not get WLAN status" or "Could not get WLAN config" the internal radio is not responding. If you repeat step 1 with the same result, call Zebra tech support.
4. Under the RF LAN INFORMATION section, verify that the SSID and IP address are set to the values you expect as described in the Printer Setup section above. If not, repeat the printer setup. If the information is still not correct, call Zebra tech support.
5. Verify that the printer is associating with the RF Access Point. Bring the printer as close as you can to the RF Access Point you are using and do a 2 key reset. Check that the value for the associated parameter under RF LAN INFORMATION is YES. If not, call Zebra tech support .
6. If you do not get a label when you try printing, verify that the printer is on.

Wireless LAN Report Example

Zebra Encore3 V79/00 11/29/00

Serial Number:

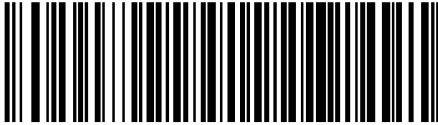

XXEC00-10-0042 ●———— Unit Serial Number

Program:

Firmware:HTE27915 /18

Chksum:116B

Software:HTLAN28M ●———— Application:
Network Printers will
have "HTLAN "prefix.

Chksum:A7EB

Ver:L4.R79.15.U126.B15.T19.A00

Cable Communications:

19200 BPS, N,8,1

Handshake:Xon-Xoff/hardware

Wireless Communications:

RF LAN INFORMATION:

Release: 3.23

Date: 11/21/2000

ipAdr = 10.14.2.204 ●———— I.P Address

fwVersion = S4.40 000720

swVersion = Version 4.40 ●———— Radio Software
Version

MAC addr = 00:a0:f8:8e:35:05

associated = YES ●———— Unit is associated
with LAN : Yes/No

Device ID = XXEC00-10-0042

subnet = 255.255.255.0

protocol = LPD

powermode = SAVE

essID = ZebraNet ●———— SSID Address

DHCP = OFF

DHCP_SAVE = OFF

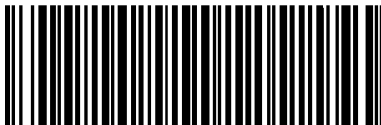

10.14.2.204 ●———— I.P Address

PROGRAMMING FOR THE DISPLAY OPTION

Introduction:

Printers with the LCD control panel option use the WML language to create screens or “cards” for the display. This section explains the WML tags and commands used to create a menu for the LCD. The file should be named INDEX.WML. This file can be sent to the printer via an FTP session or by using Label Vista. By using a line like $\$(vnd.zo.parameter\ name)$ you can display the value of that parameter name as seen in example 1. Refer to Section 14 of this manual for complete information on available parameters.

Refer to Table 1 at the end of this section for information on WML tags used by printers with the display option. The first card to be displayed should always be called “main”. The following example demonstrates the timer function and uses this to refresh the LCD to give a current battery voltage, head latch status, and paper out status. In the example each line is followed by a CR/LF (0x0D/0x0A).

Example 1:

This is a complete menu that demonstrates most of the tags from Table 1 at the end of this section. The <do> tag is shown is Example 2.

Language Tag

```
<wml>
```

Direct output to the LCD screen

```
<display>
```

Begin card named netset, with no title and a 10-second delay go back to the main card.

```
<card id="netset" title=" " ontimer="#main">
```

```
<timer value="100"></timer>
```

Display the IP address

```
<p>IP:$(vnd.zo.ip.addr)</p>
```

Line Break

```
<br />
```

continued on next page

Display the PORT number

```
<p>TCP Port:$(vnd.zo.ip.port)</p>
```

Line Break

```
<br />
```

Display the ESSID

```
<p>eSSID:$(vnd.zo.wlan.current_essid) </p>
```

Line Break

```
<br />
```

Display the associated status

```
<p>Associated:$(vnd.zo.wlan.associated) </p>
```

Display a link back to the main card

```
<p><a href="#main">back</a></p>
```

Close the card tag

```
</card>
```

Begin a card named "main", with a title and refresh rate of 1 second.

```
<card id="main" title="Zebra QL 320,Status"
ontimer="#main"> <timer value="10"></timer>
```

Line Break

```
<br />
```

Display battery voltage and battery status.

```
<p>Battery:$(vnd.zo.power.voltage)V($(vnd.zo.power.status))
</p>
```

Line Break

```
<br />
```

Display head latch status

```
<p>Latch:$(vnd.zo.head.latch)</p>
```

Line Break

```
<br />
```

Display paper out status and put a space after it.

```
<p>Paper:$(vnd.zo.media.status) </p>
```

Insert four spaces and put a link to the card netset

```
<p>    <a href="#netset">more</a></p>
```

Close the card tag

```
</card>
```

Close the display tag

```
</display>
```

Close the WML tag

```
</wml>
```

Example 1 looks like this:

```
<wml>
<display>
<card id="netset" title=" " ontimer="#main">
<timer value="100"></timer>
  <p>IP:$(vnd.zo.ip.addr)</p>
  <br/>
  <p>TCP Port:$(vnd.zo.ip.port)</p>
  <br/>
  <p>eSSID:$(vnd.zo.wlan.current_essid) </p>
  <br/>
  <p>Associated:$(vnd.zo.wlan.associated)
</p>
  <p><a href="#main">back</a></p>
</card>
<card id="main" title="Zebra QL 320,Status"
ontimer="#main"><br/>
  <timer value="10"></timer>
  <p>Battery:$(vnd.zo.power.voltage)
V($(vnd.zo.power.status)) </p>
  <br/>
  <p>Latch:$(vnd.zo.head.latch)</p>
  <br/>
  <p>Paper:$(vnd.zo.media.status) </p>
  <p>  <a href="#netset">more</a></p>
</card>
</display>
</wml>
```

continued on next page

LCD Output for Example 1:

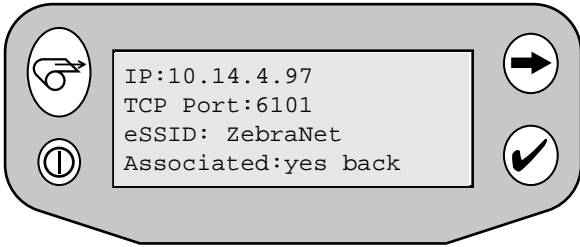
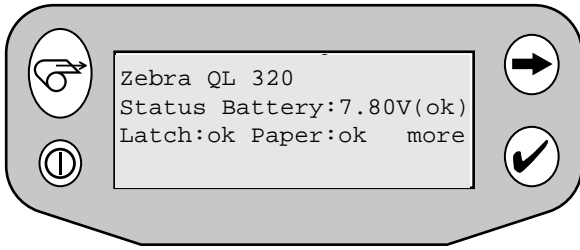

Note: The LCD screen is 20 characters across and 4 lines.

Example 2:

This example is not a complete menu setup, it is a sample card. It is meant as a tool to break down the tags and explain their use.

Comments

```
<!-- ***** -->
<!-- ***** Setup Comm Baud Card ***** -->
<!-- ***** -->
```

Begin card, the card name is baud, the title is "Com,Baud", when the 20 second timer expires go to the card called status.

```
<card id="baud" title="Com,Baud"
ontimer="#status"> <timer value="200"></timer>
```

Display the current baud rate after four spaces.

```
<p> $(vnd.zo.comm.baud)</p>
```

Do a line break

```
</br>
```

Display 9600 and put three spaces after it, if 9600 is selected then execute the setvar command to change the baud rate to 9600 in the <do>... </do> and refresh the display.

```
<do type="accept" label="9600">
<setvar name="vnd.zo.comm.baud" value="9600"/
><refresh/>
</do><p> </p>
```

Display 19200, if 19200 is selected then execute the setvar command to change the baud rate to 19200 in the <do>... </do> and refresh the display.

```
<do type="accept" label="19200">
<setvar name="vnd.zo.comm.baud" value="19200"/
><refresh/>
</do>
```

Do a line break

```
</br>
```

Link the card back to the previous menu.

```
<p><a href="#comm">Back</a> </p>
```

Link the card back to the main menu.

```
<p><a href="#main">Main</a></p>
```

End the card

```
</card>
```

continued on next page

Example 2 looks like this:

```
<!-- ***** ->
<!-- ***** Setup Comm Baud Card ***** ->
<!-- ***** ->
<card id="baud" title="Com,Baud"
ontimer="#status">
  <timer value="200"></timer>
  <p>  $(vnd.zo.comm.baud)</p>
  </br>
  <do type="accept" label="9600">
  <setvar name="vnd.zo.comm.baud"
value="9600"/><refresh/>
  </do><p>    </p>
  <do type="accept" label="19200">
  <setvar name="vnd.zo.comm.baud"
value="19200"/><refresh/>
  </do>
  </br>
  <p><a href="#comm">Back</a>    </p>
  <p><a href="#main">Main</a></p>
</card>
```

LCD Output for Example 2:

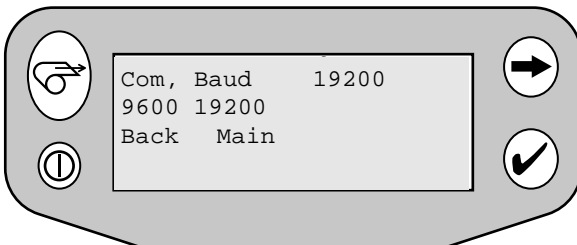

Note: The LCD screen is 20 characters across and 4 lines.

Table 1: WML Tags used on Printers with th LCD Option	
Tag	Comments
<code><wml> ... </wml></code>	Declares a WML document
<code><DISPLAY> ... </DISPLAY></code>	Sends output to LCD
<code>"<card id="" cardname"" title=""#titlename"" ontimer=""#main"" > ... </card>"</code>	Declares a card (or screen)
<code></br></code>	Line Break, on the display this will do a the equivalent to a CR/LF also please note that the display is 20 characters long the 21st character will display at the first position of the next line.
<code><p> ... </p></code>	Paragraph
<code>" "</code>	Hyper-link to another card (screen)
<code>\$(vnd.zo.printer_option)</code>	Gets printer option similar to the GETVAR command. Where printer_option is an option from the previous section that the GETVAR command is valid.
<code><!— ... —></code>	Comments
<code><timer value=nnn></timer></code>	Sets the timer value nnn = duration to wait in 10 ^{ths} of a second for the check to be press before going to the card specified in the ontimer option of the card tag.

Tag	Comments
<pre> "<do type=""accept"" label=""xxx""> <setvar name=""vnd.zo.{option}" value=""yyy""/><refresh/> </do>" </pre>	<p>Performs specific action when label ""xxx"" is selected " from the menu. The {option} is specified the same way as the SETVAR command detailed in the Section 14. The value is the new value desired. The tag <refresh/> is used to refresh the screen after the command is issued.</p>

CONFIGURATION/CONTROL COMMANDS

Introduction

The following section covers a set of commands to configure and query printer parameters and perform various printer control functions. Examples of this set of commands include setting printer's IP address, querying printer's baud rate, or instructing the printer to advance its media to top of form. This set of commands is referred to as the set/get/do commands, and is available in the printer applications version 40 and above. The software version can be ascertained by performing a two-key reset as described in Section 1 of this manual. The number in the "Software:" listing on the second report must end in 40 or above (e.g. "Software: HTLK**40**d")

These commands follow a standard format as described below.

Note: All commands must be terminated with a CR/LF (0x0D, 0x0A). Actions and parameter names must be specified in lower-case. Parameter values should be specified in lower-case unless the parameter value itself is case sensitive, such as a printer's WLAN eSSID.

Command Format

Three commands are available: **setvar**, **getvar**, and **do**.

"**Setvar**" commands are used to configure printer operating parameters to specified values.

"**Getvar**" commands are used to query the printer for its parameter values.

"**do**" commands are used to instruct the printer to perform various functions.

Entering the line `!>[parameter]` in a label file will print the value of the parameter specified between "[]"

The formats of these commands are as follows:

continued on next page

getvar Command

The getvar command is used to get the current value of printer parameters. This command must be terminated by a CR/LF (0x0D, 0x0A). The printer will respond with the parameter value of “?” if the parameter does not exist (usually due to incorrect spelling of the parameter name) or it has not been configured yet. The parameter name should be specified in lower case.

Format:

```
getvar “{parameter name}”
```

{Parameter name} The name of the parameter to be retrieved. Please refer to the parameter list for valid parameter names.

setvar Command

The setvar command is used to set parameter values in the printer. This command must be terminated by a CR/LF (0x0D, 0x0A). The parameter name must be in lower case. Parameter values must be specified in lower case, unless the parameter value itself is case sensitive, such as a printer’s WLAN eSSID.

Format:

```
setvar “{Parameter name}” “{Value}”
```

{Parameter name} The name of the parameter to be set. Please refer to the parameter list for valid parameter names.

{Value} The new value to assign to the specified parameter above.

do Command

The do command can be used to instruct the printer to perform predefined actions. Some do commands require one or more parameters. These parameters should be

enclosed in double quotes. This command must be terminated by a CR/LF (0x0D, 0x0A). The printer will perform the specified function immediately after receiving the command.

Format:

do "{Action name}" "{parameter}"

{Action name} The action to perform. Please refer to the parameter list for valid action names.

{parameter} some actions require one or more parameters. The parameters should be specified as required by the corresponding action, enclosed within double quotes. For actions that do not require a parameter an empty parameter list should be specified, i.e. "".

Commands / Parameters

Following are descriptions of each set/get/do command in detail, including the required parameters, if any, and possible choices for parameter values. Each set/get/do command described below also includes examples to demonstrate proper syntax and usage.

continued on next page

appl.date

type: getvar

This parameter refers to the printer's application date.

getvar result	Printer will respond with the applications date in the mm/dd/yy format	
Example:	Description	Get printer application's date.
	Syntax	! U1 getvar "appl.date"
	Result	"01/29/02"

appl.name

Type: getvar

This parameter refers to the printer's application name.

getvar result	Printer's application name will be returned.	
Example	Description	Get printer application name.
	Syntax	! U1 getvar "appl.name"
	Result	"htstd40a.hex "

appl.version

Type: getvar

This parameter refers to the printer's application version.

getvar result	Printer application version as a 4-digit (hex) number.	
Example	Description	Get printer application's version.
	Syntax	! U1 getvar "appl.version"
	Result	"7940"

Bluetooth™ Parameters

The following parameter names are only available with Bluetooth enabled applications. Changes made using the **setvar** command with Bluetooth parameters will be set in the printer, but will not take effect until a new link is established, power is cycled or the **device.reset** command is issued. If a link already exists the change will not effect the current connection and will not cause a disconnect.

bluetooth.address

type: getvar

This parameter is the Bluetooth device address - programmed into each radio.

getvar result	Returns the printer's Bluetooth address.	
Example	Description	Get printers Bluetooth address.
	Syntax	! U1 getvar "bluetooth.address"
	Result	"00:80:37:16:87:71"

continued on next page

bluetooth.authentication

type: getvar; setvar

This parameter sets Bluetooth authentication mode and works in combination with the “bluetooth.bluetooth_pin” parameter. When authentication is set to “default” a PIN is required to connect to the printer that is based on the friendly-name. Contact your printer supplier to obtain the algorithm that generates this PIN.

When authentication is set to “setpin”, the PIN required to connect is set in the “bluetooth.bluetooth_pin” parameter.

NOTE this parameter and the following “bluetooth.bluetooth_pin” parameter apply only when Bluetooth library versions 1.2.3 or later are installed in the printer. Refer to “Getting Printer information” in Section 1 for information on obtaining installed printer software versions

getvar result	Current authentication mode setting, “off”, “default”, “setpin”.	
Example	Description	Get the current Bluetooth authentication mode.
	Syntax	! U1 getvar “bluetooth.authentication”
	Result	“off”
setvar choices	“off”, “default”, “setpin”	
	Default	“off”
Example	Description	Enable Bluetooth authentication.
	Syntax	! U1 setvar “bluetooth.authentication” “default”
	Result	Printer will enable Bluetooth authentication with user defined PIN set in the “bluetooth.bluetooth_pin” parameter.

bluetooth.bluetooth_pin

type: getvar, setvar

This parameter is used to connect to the printer only when the “bluetooth.authentication” parameter is set to “setpin”.

This parameter is *not* used when the “bluetooth.authentication” parameter is set to “default” or “off”. See “bluetooth.authentication”.

getvar result	returns the printer’s bluetooth PIN value	
Example	Description	Instructs the printer to respond with the Bluetooth PIN value
	Syntax	!U1 getvar “bluetooth.bluetooth_pin”
setvar choices	Result	“MyPin”
	text string up to 10 characters	
	Default	“ “
Example	Description	Instructs the printer to change the Bluetooth PIN value
	Syntax	!U1 setvar “bluetooth.bluetooth_pin” “MyPin”
	Result	Changes password to “MyPin”

continued on next page

bluetooth.date

type: getvar

This parameter is the release date of the Bluetooth module.

getvar result	Printer's Bluetooth library release date in the format "mm/dd/yy"	
Example	Description	Get printer's Bluetooth module release date.
	Syntax	! U1 getvar "bluetooth.date"
	Result	"02/12/02"

bluetooth.discoverable

type: getvar; setvar

This parameter sets the Bluetooth discoverable mode.

getvar result	Current discoverable mode setting, "off" or "on"	
Example	Description	Get the current Bluetooth discoverable mode.
	Syntax	! U1 getvar
"bluetooth.discoverable"		
setvar choices	Result	"on"
	"on", "off"	
Example	Default	"on"
	Description	Disable discoverable mode.
	Syntax	! U1 setvar "bluetooth.discoverable" "off"
	Result	Printer will disable discoverable mode.

bluetooth.friendly_name

type: getvar, setvar

This parameter sets the friendly_name, which is part of the local_name used during service discovery and also affects authentication. The friendly_name is a string of up to 20 characters long; it will default to the printer serial number if not set by the user.

Changes to local_name and authentication will not occur until power is cycled or the **device.reset** command is issued.

getvar result	Returns the friendly_name	
Example	Description	Get printer friendly_name
	Syntax	! U1 getvar "bluetooth.friendly_name"
	Result	"SYGN01-11-0389"
set var choices	any string of 20 characters or less.	
	default	printer serial number
Example	Description	Set the friendly_name
	Syntax	!U1 setvar "bluetooth.friendly_name" "16314A"
	Results	Friendly_name will become: "16314A" Local_name will become: "Encore 3 16314A" Authentcation PIN will change.

bluetooth.local_name

type: getvar

This parameter is the local name that will be provided during service discovery. It is a combination of the printer model name and the friendly_name

getvar result	Returns the printer's name.	
Example	Description	Get printers local name.
	Syntax	! U1 getvar "bluetooth.local_name"
	Result	"Encore3 XXEN02-01-0317"

continued on next page

bluetooth.version

type: getvar

This parameter is the Bluetooth library version number.

getvar result	Bluetooth module version in the format "x.y.z"	
Example	Description	Get Bluetooth module version.
	Syntax	! U1 getvar "Bluetooth.version"
	Result	"1.1.0"

Comm Port Parameters

comm.parity

type: getvar; setvar

This parameter refers to the printer's comm. parity.

Note: Once the printer's communications port parameters have been changed, the host terminal must also be configured to match the new printer settings before the host can communicate again.

getvar result	Printer's comm. port parity. See setvar choices for possible values.	
Example	Description	Get printer's comm. parity setting.
	Syntax	! U1 getvar "comm.parity"
	Result	"n"
setvar choices	"n" (none), "e"even), and "o"(odd)	
	Default	"n"
Example	Description	Set printer's comm. port parity to None (no parity).
	Syntax	! U1 setvar "comm.parity" "n"
	Result	Printer will change its comm. port's parity to None.

comm.baud

type: getvar; setvar

This parameter refers to the printer's comm (cable) baud rate.

Note: Once the printer's comm. port parameters have been changed, the host terminal must also be configured to match the new printer settings before the host can communicate again

getvar result	Printer baud rate.	
Example	Description	Get printer's comm. port baud rate
	Syntax	! U1 getvar "comm.baud"
	Result	"19200"
setvar choices	"9600", "19200", "38400", "57600", "115200"	
	Default	"19200"
Example	Description	Set printer's comm. baud rate to 19200 BPS.
	Syntax	! U1 setvar "comm.baud" "19200"
	Result	Printer will change its comm. baud rate to 19200 BPS.

continued on next page

comm.stop_bits

type: getvar; setvar

This parameter refers to the printer's comm. port stop bits.

Note: Once the printer's comm. port parameters have been changed, the host terminal must also be configured to match the new printer settings before the host can communicate again

getvar result	Stop bits.	
Example	Description	Get printer's comm. port stop bits.
	Syntax	! U1 getvar "comm.stop_bits"
	Result	"1"
setvar choices	"1", "2"	
	Default	"1"
Example to	Description	Set printer's comm. port stop bits 1.
	Syntax	! U1 setvar "comm.stop_bits" "1"
	Result	Printer will configure the comm. port for 1 stop bit.

Device Parameters

device.friendly_name

type: getvar;setvar

This parameter refers to the device's friendly name. The printer will report its serial number as friendly name if a name has not been assigned to it yet.

getvar result	The friendly name assigned to the printer.	
setvar choices	A string of up to 16 characters enclosed in double quotes.	

device.reset

type: do

Instructs the printer to perform a soft reset.

do parameters	None	
Example	Description	Perform a soft reset.
	Syntax	! U1 do "device.reset" ""
	Result	The printer will perform a soft reset.

continued on next page

device.restore_defaults

type: do

Instructs the printer to restore factory default values for the specified category of parameters.

do parameters	Printer parameter category: "wlan", "ip", "display", or "power".	
Example	Description	Restore the network card's wlan parameters to their default values.
	Syntax	! U1 do "device.restore_defaults" "wlan"
	Result	Printer will restore "wlan" parameters to their factory default values (eSSID = "247", etc)

Display Parameters

display.contrast

type: getvar; setvar

This parameter refers to the contrast level on the printer's display. (Valid only on printers with an optional display installed)

getvar result	Display's contrast level, "0" through "14"	
Example	Description	Get the current display contrast level.
	Syntax	! U1 getvar "display.contrast"
	Result	"7"
setvar choices	"0" through "14", "up", "down"	
	Default	"7"
Example	Description	Set display contrast level to 8
	Syntax	! U1 setvar "display.contrast" "8"
	Result	Printer will set the display contrast to 8.

display.backlight

type: getvar; setvar

This parameter refers to the printer display backlight.

getvar result	State of backlight control, "on" or "off"	
Example	Description	Get current backlight setting.
	Syntax	! U1 getvar "display.backlight"
	Result	"on"
setvar choices	"on", "off"	
	Default	"on"
Example	Description	Turn backlight off.
	Syntax	! U1 setvar "display.backlight" "off"
	Result	Printer will turn display backlight off.

continued on next page

display.text

type: getvar; setvar

This parameter refers to the display's text content. The display text size is four lines of text, 20 characters per line.

getvar result	The text currently displayed on the printer.	
Example	Description	Get the current text displayed.
	Syntax	! U1 getvar "display.text"
	Result	"Zebra QL 320 "
setvar choices	Text to be displayed. The tab character will move text position to next line. Specifying more than 80 characters will result in text to wrap.	
	Default	"Zebra" followed by printer model e.g. "QL 320"
Example	Description	Change the displayed text
	Syntax	! U1 setvar "display.text" "Please pickup the printed SKU list and bring to customer service desk."
	Result	Printer will display "Please pickup the printed SKU list and bring to customer service desk."

File Parameters

file.delete

type: do

This command can be used to delete printer files.

Please exercise caution when deleting files and insure factory installed files are not deleted.

do parameters	Name of file to be deleted.	
Example	Description	This command instructs the printer to delete a specified file.
	Syntax	! U1 do "file.delete" "abcd.cpf"
	Result	Deletes abcd.cpf from the printer.

file.dir

type: getvar

This parameter refers to the printer file directory.

getvar result	Printer directory.	
Example	Description	Get printer file directory.
	Syntax	! U1 getvar "file.dir"
	Result	Directory
		INDEX .WML 631 CONFIG .SYS 19 1793000 Bytes Free "ok"

file.print

type: do

This command can be used to print the contents of printer files.

do parameters	File name.	
Example	Description	This command instructs the printer to print the contents of the file called config.sys.
	Syntax	! U1 do "file.print" "config.sys"
	Result	Contents of the config.sys file will be printed.

continued on next page

file.rename

type: do

This command can be used to rename printer files.

do parameters	Original filename and new filename	
Example	Description	Rename file abc.cpf to efg.cpf.
	Syntax	! U1 do "file.rename" "abc.cpf efg.cpf"
	Result	File abc.cpf will be renamed to efg.cpf.

file.run

type: do

This command can be used to execute a batch file or label file stored in the printer's file system.

do parameters	File to execute	
Example	Description	This command instructs the printer to execute the file called ftn.bat.
	Syntax	! U1 do "file.run" "ftn.bat"
	Result	The file ftn.bat will be executed.

file.type

type: do

This command can be used to retrieve contents of a file.

do parameters	Filename to display contents	
Example	Description	This command instructs the printer to respond with the contents of the file called config.sys.
	Syntax	! U1 do "file.type" "config.sys"
	Result	! U BEEP 2 PRINT

Printer Mechanism Parameters

head.latch

type: getvar

This parameter refers to the status of the printer head latch. The head latch must be closed for printing.

getvar result	"ok", "open"	
Example	Description	Get current status of print head latch.
	Syntax	! U1 getvar "head.latch"
	Result	"ok"

media.width_sense.enable

getvar; setvar

This parameter turns the Media Width Sensing option "on" or "off". This parameter only applies to printers equipped with the Media Width Sensing option, other s will ignore this command.

getvar result	"on", "off"	
Example	Description	Get current status of media width sensing option
	Syntax	! U1 getvar "media.width_sense.enable"
	Result	"on"
setvar choices	on,off	
	Default	off
Example	Description	Change the media width sensing enable status
	Syntax	! U1 setvar "media.width_sense.enable" "on"
	Result	Media width sensing is enabled

continued on next page

media.width_sense.in_mm

getvar

This parameter returns the current media width installed in the printer measured in millimeters. The “media.width_sense.enable” parameter must be set to “on”.

Note: The media width sensing mechanism has a tolerance of ± 2.5 mm

getvar result	Media width as measured in millimeters	
Example	Description	Get width of installed media
	Syntax	! U1 getvar “media.width_sense.in_mm”
	Result	104.0

media.width_sense.in_cm

getvar

This parameter returns the current media width installed in the printer measured in centimeters. The “media.width_sense.enable” parameter must be set to “on”.

Note: The media width sensing mechanism has a tolerance of $\pm .25$ cm

getvar result	Media width as measured in centimeters	
Example	Description	Get width of installed media
	Syntax	! U1 getvar “media.width_sense.in_cm”
	Result	10.4

media.width_sense.in_dots

getvar

This parameter returns the current media width installed in the printer measured in dots. The “media.width_sense.enable” parameter must be set to “on”.

Note: The media width sensing mechanism has a tolerance of ± 21 dots (at the standard resolution of 200 d.p.i.)

getvar result	Media width as measured in dots	
Example	Description	Get width of installed media
	Syntax	! U1 getvar “media.width_sense.in_dots”
	Result	832

media.width_sense.in_inches

getvar

This parameter returns the current media width installed in the printer measured in inches. The “media.width_sense.enable” parameter must be set to “on”.

Note: The media width sensing mechanism has a tolerance of $\pm .1$ ”.

getvar result	Media width as measured in inches	
Example	Description	Get width of installed media
	Syntax	! U1 getvar “media.width_sense.in_inches”
	Result	4.098

Input Parameter

input.capture

getvar;setvar

This parameter allows capturing input data in diagnostics mode. Input capture has three modes: "print", "run", and "off". The "print" and "run" modes can be used to examine data received by the printer.

When in "print" mode the printer will save incoming data to files named "in???.dmp", where ??? is a number between 001 to 999. The printer will then print the text and hexadecimal representation of data bytes received.

When in "run" mode the printer will save captured incoming data to files as above, but will otherwise run the incoming data/commands normally.

The capture files should be deleted from printer memory after retrieving them. Leaving the printer in "print" or "run" mode and not deleting the capture files will reduce the printer's available flash memory.

The "off" mode is the printer's normal operating mode. Cycling power will also return the printer to "off" mode.

getvar result	The current input capture mode.	
Example mode	Description	Get current status of input capture
	Syntax Result	! U1 getvar "input.capture" "off"
setvar choices	"print", "run", "off"	
Default	"off"	
Example 1	Description	Place the printer in "print" input capture mode.
	Syntax Result	! U1 setvar "input.capture" "print" Printer will enter diagnostics capture mode. Any data received by the printer will be saved to files named "in???.dmp" The data's text & hexadecimal representation will be printed.
Example 2	Description	Place the printer in "run" input capture mode.
	Syntax Result	! U1 setvar "input.capture" "run" Printer will enter diagnostics capture mode. Any data received by the printer will be saved to files named "in???.dmp" prior to being processed by the printer.

Media Parameters

media.sense_mode

type: getvar; setvar

This parameter refers to media sense mode.

getvar result	Media sense mode.	
Example	Description	Get current media sense mode.
	Syntax	! U1 getvar "media.sense_mode"
	Result	"bar"
setvar choices	"bar", "gap"	
	Default	"bar"
Example	Description	Set media sense mode to bar (black index mark).
	Syntax	! U1 setvar "media.sense_mode" "bar"
	Result	Printer will switch to bar sense mode.

media.status

type: getvar

This parameter refers to the paper status.

getvar result	"ok", "out"	
Example	Description	Get current media status.
	Syntax	! U1 getvar "media.status"
	Result	"ok"

media.tof

type: getvar; setvar

This parameter refers to the print's top-of-form setting. The TOF setting is used to program the distance between the top-of-form and the end of the next (positive value) or previous (negative value) eye-sense mark or gap. The eye-sense-mark or gap that is closer to the top-of form should be used for top-of-form setting. Refer to the SET-TOF command in Section 9 for more detailed information on the TOF setting.

getvar result	Current top-of-form setting.	
Example	Description	Get current top-of-form setting
	Syntax	! U1 getvar "media.tof"
	Result	"0"
setvar choices	"0" through "119"	
	Default	"119"
Example	Description	This parameter sets the printer's top of form.
	Syntax	! U1 setvar "media.tof" "119"
	Result	Printer will set top-of-form to 119.

continued on next page

media.type

type: getvar; setvar

This parameter refers to the media type that is being used.

By default, the printer will check for correct media alignment if it encounters the eye-sense mark (black horizontal bars on back of media) during a print cycle (LABEL mode). The JOURNAL command can be used to disable this automatic correction feature. The user's program is responsible for checking and assuring presence of paper when the printer is set to JOURNAL mode. Please refer to the status inquiry command (Get Extended Printer Status) for details on checking for out-of-paper condition.

getvar result	Current media type.	
Example	Description	Get current media type.
	Syntax	! U1 getvar "media.type"
	Result	"label"
setvar choices	"label", "journal"	
	Default	"label"
Example	Description	Set media type to journal.
	Syntax	! U1 setvar "media.type" "journal"
	Result	Printer will set media type to journal.

Memory Parameters

memory.flash_size

type: getvar

This parameter refers to the total amount of Flash memory.

getvar result	Flash memory size.	
Example	Description	Get Flash memory size.
	Syntax	! U1 getvar "memory.flash_size"
	Result	"2097151 Bytes"

memory.flash_free

type: getvar

This parameter refers to the amount of available Flash memory.

getvar result	Flash memory available.	
Example	Description	Get current available Flash memory.
	Syntax	! U1 getvar "memory.flash_free"
	Result	"1345000 Bytes Free"

memory.ram_size

type: getvar

This parameter refers to the total amount of Random Access Memory.

getvar result	RAM size.	
Example	Description	Get RAM size.
	Syntax	! U1 getvar "memory.ram_size"
	Result	"2097151 Bytes"

memory.ram_free

type: getvar

This parameter refers to the amount of available RAM.

getvar result	Available RAM.	
Example	Description	Get current available RAM.
	Syntax	! U1 getvar "memory.ram_free"
	Result	"456000 Bytes Free"

Odometer Parameters

odometer.label_dot_length

type: getvar

Reports the length of the last label printed (or fed), in dots. The label dot-length is set to zero when the printer is turned on. This parameter is updated every time the printer feeds or prints a label and detects a marker, either gap or bar, while printing or feeding.

getvar result	This will return the length of the last label printed (in dots)	
Example	Description	This command instructs the printer to respond with the length of the last label printed.
	Syntax	! U1 getvar "odometer.label_dot_length"
	Result	"416"

odometer.latch_open_count

type: getvar; setvar

This parameter refers to the number of times the printer's latch has been opened. The latch open count can be set to an initial value and incremented every time the latch is opened. Typically the latch is opened each time a roll of media is loaded.

getvar result	This will return the number of times the printer's latch has been opened	
Example	Description	This command instructs the printer to respond with the latch_open count.
	Syntax	! U1 getvar "odometer.latch_open_count"
	Result	"100"
setvar choices	"0" - "65535"	
	Default	"0"
Example	Description	This command instructs the printer to set the latch_open count to "0".
	Syntax	! U1 setvar "odometer.latch_open_count" "0"
	Result	The user latch open count odometer will be set to 0.

odometer.media_marker_count

type: getvar; setvar

This parameter refers to the media marker count. The media marker counter keeps track of how many labels have passed through the printer, (if they have been printed or not) by counting the bar sense marks on the back of the media. (Contrast this to the “odometer.user_label_count parameter below.) The media marker count can be set to an initial value and is incremented every time a label is printed or fed.

getvar result	This will return the number of bar sense marks that have passed through the printer	
Example	Description	This command instructs the printer to respond with the media marker count.
	Syntax	! U1 getvar “odometer.media_marker_count”
	Result	“105”
setvar choices	“0” - “65535”	
	Default	“0”
Example	Description	This command instructs the printer to set the media marker count to 0.
	Syntax	! U1 setvar “odometer.media_marker_count” “0”
	Result	The media marker count odometer will be set to 0.

odometer.user_label_count

type: getvar; setvar

This parameter refers to the user label count. The user label counter keeps track of how many labels have been printed since the last re-set of the counter. The user's label count can be set to an initial value and incremented every time a label is printed.

Note the difference from this command to the "odometer.media_marker_count" parameter above.

getvar result	This will return the number of labels printed by the printer	
Example	Description	This command instructs the printer to respond with the user label count.
	Syntax	! U1 getvar "odometer.user_label_count"
	Result "100"	
setvar choices	"0" - "65000"	
	Default	"0"
Example	Description	This command instructs the printer to set the user label count to 0.
	Syntax	! U1 setvar "odometer.user_label_count" "0"
	Result	The user label count odometer will be set to 0.

Power Parameters

power.ascii_graph

type: getvar

This parameter refers the battery status depicted by ASCII graphics characters.

getvar result	The battery graph, represented by ASCII graphics characters.	
Example	Description	Get current battery status graph.
	Syntax	! U1 getvar "power.ascii_graph"
	Result	■ ■ ■ ■ □ □ □

power.dtr_power_off

type: getvar; setvar

This parameter refers to the remote printer power control. DTR power off is used for power management. When DTR is enabled the printer can be powered on and off via the DSR signal. When DTR-power off is enabled, a low to high transition will cause the printer to turn ON and a high to low transition will cause the printer to turn OFF. The printer will stay ON as long as DSR is high unless it reaches low battery shutdown or receives a command to shut down.

NOTE: The inactivity time-out is disabled while DSR is active.

getvar result	Current DTR power-off setting.	
Example	Description	Get current DTR power-off setting.
	Syntax	! U1 getvar "power.dtr_power_off"
	Result	"on"
setvar choices	"on", "off"	
	Default	"on"
Example	Description	Enable DTR power-off.
	Syntax	! U1 setvar "power.dtr_power_off" "on"
	Result	Printer will enable DTR power-off.

power.inactivity_timeout

type: *getvar*; *setvar*

This parameter refers to the inactivity timeout.

getvar result	Current inactivity timeout in seconds.	
Example	Description	Instructs the printer to respond with the inactivity timeout value.
	Syntax	! U1 getvar "power.inactivity_timeout"
	Result	"120 Seconds"
setvar choices	"0" through "65535". Values are specified in seconds. A value of "0" disables inactivity timeout.	
	Default	"120"
Example	Description	Set inactivity timeout to 120 seconds.
	Syntax	! U1 setvar "power.inactivity_timeout" "120"
	Result	Printer inactivity timeout will be set to 120 seconds.

power.low_battery_timeout

type: *getvar*; *setvar*

This parameter refers to the low battery timeout. When the printer reaches the low battery state this timeout will become active. The printer will shut down after the specified low battery time out

getvar result	Current low-battery timeout in seconds.	
Example	Description	Get current low-battery timeout.
	Syntax	! U1 getvar "power.low_battery_timeout"
	Result	"60"
setvar choices	"0" through "65535". Values are specified in seconds. A value of "0" disables low-battery timeout.	
	Default	"60"
Example	Description	Set low-battery timeout to 60 seconds.
	Syntax	! U1 setvar "power.low_battery_timeout" "60"
	Result	Printer low-battery timeout will be set to 60.

power.low_battery_shutdown

type: getvar

This parameter refers to the low battery shutdown level.

getvar result	Current low-battery shutdown level in volts.	
Example	Description	Get current low-battery shutdown level.
	Syntax	! U1 getvar "power.low_battery_shutdown"
	Result	"6.47(166)"

power.low_battery_warning

type: getvar

This parameter refers to the low battery warning level.

getvar result	Current low-battery warning level in volts.	
Example	Description	Get current low-battery warning level.
	Syntax	! U1 getvar "power.low_battery_warning"
	Result	"6.86(176)"

power.percent_full

type: getvar

This parameter refers to the battery status.

getvar result	Battery status as percent full.	
Example	Description	Get current battery status.
	Syntax	! U1 getvar "power.percent_full"
	Result	" 43% Full"

power.status

type: getvar

This parameter refers to the battery status.

getvar result	"ok", "low"	
Example	Description	Get current battery status.
	Syntax	! U1 getvar "power.status"
	Result	"ok"

continued on next page

power.voltage

type: getvar

This parameter refers to the battery voltage.

getvar result	Battery voltage.	
Example	Description	Get current battery voltage.
	Syntax	! U1 getvar "power.voltage"
	Result	"7.25"

Test Function Parameters

test.feed

type: do

This command can be used to advance media to top-of-form.

do parameters	None.	
Example	Description	Perform form feed.
	Syntax	! U1 do "test.feed" ""
	Result	Printer will advance to top-of-form.

test.print_diags

type: do

This command can be used to print a diagnostics report.

do parameters	None.	
Example	Description	Print diagnostics report.
	Syntax	! U1 do "test.print_diags" ""
	Result	Printer will print a diagnostics report.

test.report_diags

type: do

This command can be used to retrieve a diagnostics report from the printer.

do parameters	None.	
Example	Description	Retrieve diagnostics report.
	Syntax	! U1 do "test.report_diags" ""
	Result	Zebra QL 320 V79.40 02/01/02 CHK FFFF End of report.

Networking Parameters

The following parameter names can be used only with the network application versions 40 and above. Any changes made using the **setvar** command will not take effect until the printer's power has been cycled or the `device.reset` command is issued.

card.mac_addr

type: getvar

This parameter refers to the MAC address of the network card.

getvar result	MAC address of the printer	
Example	Description	This parameter instructs the printer to respond with the MAC address.
	Syntax	! U1 getvar "card.mac_addr"
	Result	"00:A0:F8:3A:A5:89"

ip.addr

type: getvar; setvar

This parameter refers to the IP address of the printer. The DHCP setting ("ip.dhcp.enable" parameter) must be "off" to change the printer's IP address.

getvar result	The printer's IP address	
Example	Description	Instructs the printer to respond with its current IP address
	Syntax	! U1 getvar "ip.addr"
	Result	"10.14.4.159"
setvar choices	Any valid IP address	
	Default	0.0.0.0
Example	Description	Instructs the printer to change its IP address to 10.14.4.235.
	Syntax	! U1 setvar "ip.addr" "10.14.4.235"
	Result	The IP address will change to 10.14.4.235 upon cycling the power or issuing the <code>device.reset</code>

continued on next page

ip.bootp.enable

type: getvar; setvar

This parameter will turn BOOTP on or off. BOOTP is a method for acquiring an IP address, netmask, and gateway automatically on printer power-up. It requires a BOOTP server on the local network.

If you are using static ip addressing, BOOTP must be "off".

NOTE: It is not recommended that BOOTP and DHCP both be enabled at the same time since this may increase the printer power-up initialization time. If both BOOTP and DHCP are enabled at the same time, the printer will first try BOOTP and if it does not receive a response after several seconds, it will then try DHCP. You should contact your network administrator to determine whether your network supports either BOOTP or DHCP and enable only the proper parameter on the printer.

getvar result	The current BOOTP setting.	
Example	Description	Instructs the printer to respond with the current BOOTP setting.
	Syntax Result	! U1 "getvar" "ip.bootp enable" "off"
setvar choices	"on" – Printer will use BOOTP to get its IP information on startup. "off" – Printer will not use BOOTP.	
	Default	"off"
Example	Description	Turn the BOOTP feature on
	Syntax	! U1 setvar "ip.bootp.enable" "on"
	Result	On power-up, the printer will use the BOOTP protocol to receive its IP settings from a network server.

ip.dhcp.enable

type: getvar; setvar

This parameter refers to DHCP setting. DHCP must be set to “off” before setting a static IP address.

NOTE: It is not recommended that BOOTP and DHCP both be enabled at the same time since this may increase the printer power-up initialization time. If both BOOTP and DHCP are enabled at the same time, the printer will first try BOOTP and if it does not receive a response after several seconds, it will then try DHCP. You should contact your network administrator to determine whether your network supports either BOOTP or DHCP and enable only the proper parameter on the printer.

getvar result	The printer printer's DHCP status (on or off)	
Example	Description	This command instructs the printer to respond with DHCP setting.
	Syntax	! U1 getvar "ip.dhcp.enable"
	Result	"on"
setvar choices	"on", "off"	
	Default "on"	
Example	Description	This command instructs the printer to enable DHCP
	Syntax	! U1 setvar "ip.dhcp.enable" "off"
	Result	The printer's DHCP will be off upon cycling printer power or issuing the device.reset

ip.dhcp.cid_prefix

type: getvar; setvar

This parameter defines the prefix to be prepended to the DHCP client identifier (option 61) when DHCP is enabled and “ip.dhcp.cid_type” is set to “0”.

NOTE: This parameter is only applicable if “ip.dhcp.enable” is set to “on”.

getvar result	The current client identifier prefix.	
Example	Description	This command instructs the printer to respond with the client identifier prefix.
	Syntax	! U1 getvar “ip.dhcp.cid_prefix”
	Result	“”
setvar choices	Any text string up to 10 characters in length	
	Default	“”
Example	Description	Change CID prefix to “ZEB”.
	Syntax	! U1 setvar “ip.dhcp.cid_prefix” “ZEB”
	Result	The next time the printer sends a DHCP request, if “ip.dhcp.cid_type” is “0”, the client identifier sent will be prefixed with the string “ZEB”. e.g., if “ip.dhcp.cid_value” is “PRT001”, the actual client identifier sent will be “ZEBPRT001”.

continued on next page

ip.dhcp.cid_type

type: getvar; setvar

This parameter defines the type of Client Identifier (option 61) that will be sent if DHCP is enabled. A value of “1” means the type is “Ethernet” and the printer’s MAC address will be used. A value of “0” means the type is “synthetic” and the client identifier sent will be “ip.dhcp.cid_prefix” concatenated with “ip.dhcp.cid_value”.

NOTE: This parameter is only applicable if “ip.dhcp.enable” is set to “on”.

getvar result	The current Client Identifier type to be used with DHCP.	
Example	Description	This command instructs the printer to respond with the client identifier type.
	Syntax Result	! U1 getvar “ip.dhcp.cid_type” “1”
setvar choices	• “0”: synthetic string • “1”: use printer’s MAC address	
	Default	“1”
Example	Description	Enable “synthetic” Client Identifier.
	Syntax Result	! U1 setvar “ip.dhcp.cid_type” “0” The next time the printer is powered-on and DHCP is enabled, the Client Identifier (option 61) sent will be a “synthetic” type.

ip.dhcp.cid_value

type: getvar; setvar

This parameter defines the unique value to be used as the client identifier (option 61) if DHCP is enabled and “ip.dhcp.cid_type” is “1”.

NOTE: This parameter is only applicable if “ip.dhcp.enable” is set to “on”.

getvar result	The current client identifier value.	
Example	Description	This command instructs the printer to respond with the client identifier value.
	Syntax	! U1 getvar “ip.dhcp.cid_value”
	Result	“ _ ”
setvar choices	Any text string up to 20 characters in length	
	Default	<ul style="list-style-type: none">• If “ip.dhcp.cid_type” is “0” - the default is the printer’s friendly name (see “device.friendly_name”)• If “ip.dhcp.cid_type” is “1” - the default is the printer’s MAC address
Example	Description	Change CID value to “PRT001”.
	Syntax	! U1 setvar “ip.dhcp.cid_value” “PRT001”
	Result	The next time the printer sends a DHCP request, if “ip.dhcp.cid_type” is “0”, the client identifier sent will be “ip.dhcp.cid_prefix” plus “PRT001” e.g., if “ip.dhcp.cid_prefix” is “ZEB”, the actual client identifier sent will be “ZEBPRT001”.

continued on next page

ip.ftp.enable

type: getvar; setvar

This parameter refers to the FTP protocol setting.

getvar result	Returns printer's FTP status (on or off)	
Example	Description	This command instructs the printer to respond with the FTP setting.
	Syntax	! U1 getvar "ip.ftp.enable"
setvar choices	Result	"on"
	"on", "off"	
Example	Default	"on"
	Description	This command instructs the printer to disable FTP.
	Syntax	! U1 setvar "ip.ftp.enable" "off"
	Result	FTP service will be disabled upon cycling the power or issuing the device.reset

ip.gateway

type: getvar; setvar

This parameter refers to the gateway address. This value is ignored if DHCP is enabled.

getvar result	This will return the gateway setting in the printer.	
Example	Description	This command instructs the printer to respond with the gateway address.
	Syntax	! U1 getvar "ip.gateway"
setvar choices	Result	"10.19.5.1"
	Any valid gateway address.	
Example	Default	"0.0.0.0"
	Description	This command instructs the printer to change the gateway address to 38.10.4.1
	Syntax	! U1 setvar "ip.gateway" "38.10.4.1"
	Result	This will set the gateway address to 38.10.4.1 upon cycling the power or issuing the device.reset.

ip.http.enable

type: getvar; setvar

This parameter refers to the HTTP protocol / web sever setting.

getvar result	This will return the HTTP protocol status. (on or off)	
Example	Description	This command instructs the printer to respond with the HTTP setting.
	Syntax Result	! U1 getvar "ip.http.enable" "on"
setvar choices	"on", "off"	
	Default	"on"
Example	Description	This command instructs the printer to enable the HTTP protocol.
	Syntax Result	! U1 setvar "ip.http.enable" "on" The HTTP protocol will be turned on upon cycling the power or issuing the device.reset.

ip.lpd.enable

type: getvar; setvar

This parameter refers to the LPD protocol setting.
LPD communications from the host should be directed to port 515.

getvar result	This will return the LPD protocol status. (on or off)	
Example	Description	This command instructs the printer to respond with the LPD value.
	Syntax Result	! U1 getvar "ip.lpd.enable" "on"
setvar choices	"on", "off"	
	Default	"on"
Example	Description	This command instructs the printer to enable the LPD protocol.
	Syntax Result	! U1 setvar "ip.lpd.enable" "on" The LPD protocol will be turned on upon cycling the power or issuing the device.reset

continued on next page

ip.netmask

type: getvar; setvar

This parameter refers to the subnet mask address. This value is ignored if DHCP is enabled.

getvar result	This will return the printer's subnet mask.	
Example	Description	This command instructs the printer to respond with the subnet mask.
	Syntax	! U1 getvar "ip.netmask"
	Result	"255.255.255.0"
setvar choices	Any valid netmask.	
	Default	"255.255.255.0"
Example	Description	This command instructs the printer to change the subnet mask to 255.255.0.0.
	Syntax	! U1 setvar "ip.netmask" "255.255.0.0"
	Result	The subnet mask will be set to 255.255.0.0 upon cycling the power or issuing the device.reset.

ip.ping_remote

type: do

This parameter directs the printer to ping a specified address "x" number of times. The address to be pinged is set by setvar **ip.remote**.

do parameters	ip address; number of times to ping	
Example	Description	This command instructs the printer to ping the address set by the <i>ip.remote</i> parameter ten times,
	Syntax	! U1 do "ip.ping_remote "10"
	Result	Printer creates a report similar to the following: Pinging 10.14.4.162 10 times Results: 10 of 10 succeeded Min:20 Max:40 Avg:22 (min/max times in mSec.)

ip.pop3.enable

type: getvar; setvar

This parameter refers to whether the printer will query a POP3 mailbox for mail.

getvar result	This will return the POP3 enable status (on or off)	
Example	Description	This command instructs the printer to respond with the POP3 setting
	Syntax	! U1 getvar "ip.pop3.enable"
	Result	"on"
setvar choices	"on", "off"	
	Default	"off"
Example	Description	This command instructs the printer to disable the POP3 querying.
	Syntax	! U1 setvar "ip.pop3.enable" "on"
	Result	This will turn on the POP3 querying upon cycling the power or issuing the device.reset.

ip.pop3.password

type: getvar; setvar

This parameter refers to the POP3 mailbox password .
This only applies if **ip.pop3.enable** is set to "on".

getvar result	Returns the POP3 password set in the printer.	
Example	Description	Instructs the printer to respond with the POP3 password value
	Syntax	! U1 getvar "ip.pop3.password"
	Result	"password"
setvar choices	Text string up to 19 characters in length	
	Default	"password"
Example	Description	Instructs the printer to change the POP3 password.
	Syntax	! U1 setvar "ip.pop3.username" "new_password"
	Result	Changes the password to new_password. This change will take effect upon cycling the power or issuing the device.reset.

continued on next page

ip.pop3.poll

type: getvar; setvar

This parameter refers to the frequency (in seconds) that the printer will query a POP3 mailbox for new mail. This only applies if the **ip.pop3.enable** is set to "on".

NOTE: A poll value of less than thirty seconds is not recommended. The printer is unresponsive for several seconds when polling for email depending on data transfer time from the server to the printer.

get var results	This will return the poll frequency in seconds	
Example	Description	This command instructs the printer to respond with the POP3 poll frequency (in seconds).
	Syntax Result	! U1 getvar "ip.pop3.poll" "240"
set var choices	"0" through "65535" A value of "0" will cause the printer to only query the POP3 mailbox once on printer power up.	
	Default	"240"
Example	Description	This command instructs the printer to poll the POP3 mailbox every four minutes.
	Syntax Result	! U1 setvar "ip.pop3.poll" "240" This will set the pop3 polling frequency to 240 seconds (4 minutes).

ip.pop3.print_body

type: getvar; setvar

This parameter refers to whether the email body will be printed when the email is retrieved via POP3. This only applies if the **ip.pop3.enable** is set to on.

getvar result	Returns the pop3 print body status (on or off)	
Example	Description	Instructs the printer to respond whether or not the it will print the body of email retrieved via POP3.
	Syntax	! U1 getvar "ip.pop3.print_body"
	Result	"on"
set var choices	"on", "off"	
	Default	"Off"
Example	Description	Instructs the printer not to print the body of the email retrieved via POP3.
	Syntax	! U1 setvar "ip.pop3.print_body" "off"
	Result	Turns off the pop3 print body parameter.

ip.pop3.print_headers

type: getvar; setvar

This parameter refers to whether the headers (From, Date, and Subject fields) of the email are to be printed. This only applies if the **ip.pop3.enable** is set to "on".

getvar result	Returns the status of the pop3 print headers (on or off).	
Example	Description	Instructs the printer to respond with the POP3 print_headers value.
	Syntax	! U1 getvar "ip.pop3.print_headers"
	Result	"off"
setvar choices	"on", "off"	
	Default	"off"
Example	Description	Instructs the printer to enable the POP3 print_headers.
	Syntax	! U1 setvar "ip.pop3.print_headers" "on"
	Result	Turns the pop3 print headers on.

ip.pop3.save_attachments

type: getvar; setvar

This parameter refers to whether email attachments are to be saved to the flash file system in the printer. This only applies if the **ip.pop3.enable** is set to on.

Note: attachment file names will be truncated to 11 characters (8 characters, with a 3-character extension.)

getvar result	This will return the pop3 save attachments status (on or off)	
Example	Description	This command instructs the printer to respond with the POP3 save attachments value
	Syntax	! U1 getvar "ip.pop3.save_attachments"
	Result	"off"
setvar choices	"on", "off"	
	Default	"on"
Example	Description	This command instructs the printer to disable POP3 save attachments.
	Syntax	! U1 setvar "ip.pop3.save_attachments" "off"
	Result	This will turn the pop3 save attachments off.

ip.pop3.server_addr

type: getvar; setvar

This parameter refers to the POP3 server IP address the printer contacts when checking for new mail. This only applies if **ip.pop3.enable** is set to on.

getvar result	This will return the POP3 server address setting.	
Example	Description	Instructs the printer to respond with the server address.
	Syntax	! U1 getvar "ip.pop3.server_addr"
	Result	"0.0.0.0"
setvar choices	Any valid POP3 server address	
	Default	"0.0.0.0"
Example	Description	Instructs the printer to change the POP3 server address to 10.19.3.1.
	Syntax	! U1 setvar "ip.pop3.server_addr" "10.19.3.1"
	Result	Sets the POP3 server address to 10.19.3.1

ip.pop3.username

type: getvar; setvar

This parameter refers to the POP3 username. This only applies if the **ip.pop3.enable** is set to on.

getvar result	This command instructs the printer to respond with the POP3 username value.	
Example	Description	This command instructs the printer to respond with the POP3 username value.
	Syntax	! U1 getvar "ip.pop3.username"
	Result	"user"
setvar choices	Text string up to 19 characters in length	
	Default	User
Example	Description	This command instructs the printer to change the POP3 username to user1.
	Syntax	! U1 setvar "ip.pop3.username" "user1"
	Result	This will change the pop3 username to user1.

ip.pop3.verbose_headers

type: getvar; setvar

This parameter refers to whether all the email headers of the email will be printed. This only applies if **ip.pop3.enable** and **ip.pop3.print_headers** are set to "on".

getvar result	This will return the pop3 verbose headers status (on or off).	
Example	Description	This command instructs the printer to respond with the POP3 verbose header value.
	Syntax	! U1 getvar "ip.pop3.verbose_headers"
	Result	"off"
setvar choices	"on", "off"	
	Default	"off"
Example	Description	Instructs the printer to enable POP3 verbose headers.
	Syntax !	U1 setvar "ip.pop3.verbose_headers" "on"
	Result	Turns POP3 verbose headers on. All email headers will be printed.

ip.port

type: getvar; setvar

This parameter refers to the port number that the TCP and UDP print service is listening on. Normal TCP communications from the host should be directed to this port.

getvar result	Returns current TCP/UDP port setting.	
Example	Description	Instructs the printer to respond with the TCP/UDP port number.
	Syntax	! U1 getvar "ip.port"
	Result	"6101"
setvar choices	"1" -"65535"; excluding 20, 21 (used for FTP), 23 (used for telnet), 80 (used for HTTP), and 515 (used for LPD).	
	Default	"6101"
Example	Description	Instructs the printer to set the TCP/UDP port number to 6102.
	Syntax	! U1 setvar "ip.port" "6102"
	Result	Changes the TCP/UDP listening port to 6102.

ip.remote

type: getvar; setvar

This parameter refers to the remote server address or name.

getvar result	Returns the current remote server address or name.	
Example	Description	Instructs the printer to respond with the currently stored remote server address or name.
	Syntax	! U1 getvar "ip.remote"
	Result	"0.0.0.0"
setvar choices	Any IP Address or name up to 39 characters long.	
	Default	"0.0.0.0"
Example	Description	Instructs the printer to change the remote IP address to 10.14.4.235.
	Syntax	! U1 setvar "ip.remote" "10.14.4.235"
	Result	This will change the remote server to 10.14.4.235.

ip.remote_autoconnect

type: getvar; setvar

This parameter will determine whether the printer will attempt to automatically initiate a TCP connection to a remote server on power-up. If the parameter "ip.remote" has a valid server address and "ip.remote_autoconnect" is set to "on", the printer will initiate a TCP connection to the address defined by "ip.remote" using the destination port number defined by "ip.remote_port". If "ip.remote_autoconnect" is "on", the printer will attempt to maintain a constant connection to this server address. Anytime the connection is lost, the printer will attempt to re-establish the connection to the remote address.

getvar result	The current auto-connect setting	
Example	Description	Instructs the printer to respond with the currently stored "ip.remote_autoconnect" status
	Syntax	! U1 getvar "ip.remote_autoconnect"
	Result	"off"
setvar choices	"on", "off"	
	Default	"off"
Example	Description	Instructs the printer to change the ip.remote_autoconnect status to "on".
	Syntax	! U1 setvar "ip.remote_autoconnect" "on"
	Result	On power up, the printer will initiate a TCP socket connection to the address defined by "ip.remote", connecting to the TCP port number defined by "ip.remote_port." Anytime the connection is lost, the printer will automatically attempt to re-establish it.

continued on next page

ip.remote_port

type: getvar; setvar

This parameter defines the destination TCP port number to connect to when used in conjunction with “ip.remote_autoconnect” and “ip.remote” parameters.

getvar result	Returns the current TCP port number.	
Example	Description	Instructs the printer to respond with the currently stored TCP Port number.
	Syntax	! U1 getvar “ip.remote_port”
	Result	“10013”
setvar choices	“0” - “65535”.	
	Default	“10013”
Example	Description	Instructs the printer to change the TCP port number to “6000”.
	Syntax	! U1 setvar “ip.remote” “6000”
	Result	If “ip.remote_autoconnect” is “on”, the printer will attempt to connect to TCP port 6000 of the remote server.

ip.smtp.enable

type: getvar; setvar

This parameter refers to the SMTP protocol.

getvar result	This will return the status of the SMTP protocol (on or off)	
Example	Description	Instructs the printer to return the SMTP setting.
	Syntax	! U1 getvar “ip.smtp.enable”
	Result	“off”
setvar choices	“on”, “off”	
	Default	On
Example	Description	Instructs the printer to enable the SMTP protocol.
	Syntax	! U1 setvar “ip.smtp.enable” “on”
	Result	This will turn on the smtp protocol in the printer.

ip.smtp.server_addr

type: getvar; setvar

This parameter refers to the IP address of the SMTP server used for sending email.

getvar result	Returns the IP address of the SMTP server used for sending email.	
Example	Description	Instructs the printer to respond with the current SMTP server address.
	Syntax	! U1 getvar "ip.smtp.server_addr"
	Result	"0.0.0.0"
setvar choices	Any valid IP address assigned to the SMTP server.	
	Default	"0.0.0.0"
Example	Description	Instructs the printer to change the SMTP server address to 10.10.10.10.
	Syntax	! U1 setvar "ip.smtp.server_addr" "10.10.10.10"
	Result	Changes the SMTP server address the printer uses to send email to 10.10.10.10

ip.snmp.enable

type: getvar; setvar

This parameter refers to the SNMP protocol. Enabling this parameter will allow the printer to be monitored and managed remotely via network management programs supporting SNMP.

getvar result	Returns the SNMP status (on or off).	
Example	Description	Instructs the printer to respond with the SNMP setting.
	Syntax	! U1 getvar "ip.snmp.enable"
	Result	"on"
setvar choices	"on", "off"	
	Default	"on"
Example	Description	Instructs the printer to disable the SNMP protocol.
	Syntax	! U1 setvar "ip.snmp.enable" "off"
	Result	Turns off the SNMP protocol.

continued on next page

ip.snmp.get_community_name

type: getvar; setvar

This parameter is used when making SNMP queries. The SNMP client must supply the get community name that matches the printer's get community name in order to query any SNMP data.

getvar result	Returns the SNMP community name.	
Example	Description	Instructs the printer to get the SNMP get community string.
	Syntax	! U1 getvar "ip.snmp_get_community_name"
	Result	"public"
setvar choices	Any string up to 20 characters long	
	Default	"public"
Example	Description	Instructs the printer to set the SNMP set community string.
	Syntax	! U1 setvar "ip.snmp_get_community_name" "private"
	Result	Changes the community name to "private".

ip.snmp.set_community_name

type: getvar; setvar

This parameter is used when changing SNMP data remotely. The SNMP client must supply the set community name that matches the printer's set community name in order to alter any SNMP data.

getvar result	This will return the SNMP set community name value.	
Example	Description	This command instructs the printer to return the printer's SNMP "set" community string.
	Syntax	! U1 getvar "ip.snmp.set_community_name"
	Result	"private"
setvar choices	Valid values : Any string up to 20 characters long	
	Default	"private"
Example	Description	This command instructs the printer to set the SNMP set community string.
	Syntax	! U1 setvar "ip.snmp_set_community_name" "private1"
	Result	"private1"

continued on next page

ip.snmp.create_mib

type: do

This parameter refers to creating a file of the printer's MIB.

do parameters	Filename (NOTE: The filename is up to eight characters in length with a three-character extension.)	
Example	Description	This command instructs the printer to create an SNMP MIB file based in the current set/get parameters in the printer's application. The file will be stored on the printer's file system with the filename supplied as the parameter in the do command. The MIB file can then be retrieved (via Label Vista, FTP, or other wired / wireless connection to the printer) and passed onto any SNMP-based utility to provide a means to monitor and configure all the printer's parameters via SNMP.
	Syntax	! U1 do "ip.snmp.create_mib" "EXAMPLE1.MIB"
	Result	EXAMPLE1.MIB will be created in the printer's file system with the printer MIB information stored in it.

ip.tcp.enable

type: getvar; setvar

This parameter refers to the TCP socket protocol.

getvar result	Returns the TCP protocol status. (on or off)	
Example	Description	Instructs the printer to respond with the TCP setting.
	Syntax	! U1 getvar "ip.tcp.enable"
	Result	"on"
setvar choices	"on", "off"	
	Default	"on"
Example	Description	Instructs the printer to enable the TCP protocol.
	Syntax	! U1 setvar "ip.tcp.enable" "on"
	Result	The TCP protocol will be turned on upon cycling the power or issuing device.reset.

ip.telnet.enable

type: getvar; setvar

This parameter refers to the TELNET protocol.

getvar result	Returns the TELNET protocol status. (on or off)	
Example	Description	Instructs the printer to respond with the TELNET setting.
	Syntax	! U1 getvar "ip.telnet.enable"
	Result	"on"
setvar choices	"on", "off"	
	Default	"on"
Example	Description	Instructs the printer to enable the TELNET protocol.
	Syntax	! U1 setvar "ip.telnet.enable" "on"
	Result	The TELNET protocol will be turned on upon cycling the power or issuing the device.reset.

ip.udp.enable

type: getvar ;setvar

This parameter refers to the UDP socket protocol.

getvar result	Returns the UDP protocol status. (on or off)	
Example	Description	This command instructs the printer to respond with the UDP setting.
	Syntax	! U1 getvar "ip.udp.enable"
	Result	"on"
setvar choices	"on", "off"	
	Default	"on"
Example	Description	This command instructs the printer to enable the UDP protocol.
	Syntax	! U1 setvar "ip.UDP.enable" "on"
	Result	The UDP protocol will be turned on upon cycling the power or issuing the device.reset.

WLAN Parameters

NOTE: The following “wlan.xxx” parameters are effective on QL series printers only. Cameo and Encore “N” series printers must use the “LAN” comand set detailed in section 12.

wlan.associated

type: getvar

This parameter refers to whether the printer is associated with an access point (AP).

getvar result	This will return “yes” if the printer is associated and “no” if the printer is not associated with the access point.	
Example	Description	This command instructs the printer to respond with yes or no.
	Syntax	! U1 getvar “wlan.associated”
	Result	“yes”

wlan.auth_type

type: getvar;setvar

This parameter selects the authentication service to be used between the printer and the Access Point. Open System and Shared Key are the two types of authentication services.

getvar result	Current authentication type.	
Example	Description	This command instructs the printer to retrieve the current authentication type.
	Syntax	! U1 getvar “wlan.auth_type”
	Result	“open”
setvar choices	“open”, “shared”	
	Default	“open”
Example	Description	This command instructs the printer to set the authentication type to Shared Key.
	Syntax	! U1 setvar “wlan.auth_type” “shared”
	Result	The authentication type will be set to Shared Key after power cycle.

wlan.current_essid

type: getvar

This parameter refers to the eSSID of the network currently associated with the printer. The eSSID is returned only if the printer is associated with an access point.

getvar result	This will return the eSSID that the printer is associated with in Infrastructure mode. When the printer is in Ad Hoc mode it will return the stored eSSID. (For more information on Infrastructure and Ad Hoc modes see wlan.operating_mode .)	
Example	Description	This command instructs the printer to respond with the current eSSID.
	Syntax	!U1 getvar "wlan.current_essid"
	Result	"ZebraNet"

wlan.current_tx_rate

type: getvar

This parameter retrieves the current transmit (tx) rate (mbps). This rate will vary depending on several factors such as the Access Point's settings and the printer's distance from the AP. Possible values are "1", "2", "5.5", and "11".

getvar result	Current transmit rate	
Example	Description	This command instructs the printer to respond with the current tx rate.
	Syntax	!U1 getvar "wlan.current_tx_rate"
	Result	"11"

continued on next page

wlan.encryption_index

type getvar; setvar

This parameter refers to the WEP (Wired Equivalent Privacy) encryption key index. This parameter determines which one of the four encryption keys is to be used by the client (printer).

getvar result	This will return the current encryption key index that is in use by the printer.	
Example	Description	This command instructs the printer respond with the encryption key index value.
	Syntax Result	! U1 getvar "wlan.encryption_index" "1"
setvar choices	"1", "2", "3", or "4"	
	Default	"1"
Example	Description	Instructs the printer to set the encryption key index.
	Syntax	! U1 setvar "wlan.encryption_index" "1"
	Result	Sets the encryption key index to 1.

wlan.encryption_key1

type: getvar; setvar

This parameter refers to the first indexed WEP encryption key. The WEP encryption key is a hexadecimal string that is either 10 or 26 characters long depending on encryption method (40-bit or 128 bit). This key should match the wireless network WEP encryption key 1.

getvar result	This will return the encryption first encryption key.	
Example	Description	This command instructs the printer respond with the encryption key value. (This example assumes that the printer is using 40-bit encryption.)
	Syntax Result	! U1 getvar "wlan.encryption_key1" "0000000000"
setvar choices	10 hexadecimal characters for 40-bit encryption 26 hexadecimal characters for 128-bit encryption	
	Default	All zeros
Example	Description	This command instructs the printer to set the encryption key value. (This example assumes that the printer is using 40-bit encryption.)
	Syntax	! U1 setvar "wlan.encryption_key1" "A1B2C3D4F5"
	Result	The first encryption key will be set to A1B2C3D4F5

continued on next page

wlan.encryption_key2

type: getvar; setvar

This parameter refers to the second indexed WEP encryption key. The WEP encryption key is a hexadecimal string that is either 10 or 26 characters long depending on encryption method (40-bit or 128 bit). This key should match the wireless network WEP encryption key 2.

getvar result	This will return the encryption second encryption key.	
Example	Description	This command instructs the printer respond with the encryption key value. (This example assumes that the printer is using 40-bit encryption.)
	Syntax Result	! U1 getvar "wlan.encryption_key2" "0000000000"
setvar choices	10 hexadecimal characters for 40-bit encryption 26 hexadecimal character for 128-bit encryption	
	Default	All zeros
Example	Description	This command instructs the printer to set the encryption key value. (This example assumes that the printer is using 40-bit encryption.)
	Syntax	! U1 setvar "wlan.encryption_key2" "A1B2C3D4F5"
	Result	The first encryption key will be set to A1B2C3D4F5

continued on next page

wlan.encryption_key3

type: getvar; setvar

This parameter refers to the third indexed WEP encryption key. The WEP encryption key is a hexadecimal string that is either 10 or 26 characters long depending on encryption method (40-bit or 128 bit). This key should match the wireless network WEP encryption key 3.

getvar result	This will return the encryption third encryption key.	
Example	Description	This command instructs the printer respond with the encryption key value. (This example assumes that the printer is using 40-bit encryption.)
	Syntax Result	! U1 getvar "wlan.encryption_key3" "0000000000"
setvar choices	10 hexadecimal characters for 40-bit encryption 26 hexadecimal character for 128-bit encryption	
	Default	All zeros
Example	Description	This command instructs the printer to set the encryption key value. (This example assumes that the printer is using 40-bit encryption.)
	Syntax	! U1 setvar "wlan.encryption_key3" "A1B2C3D4F5"
	Result	The third encryption key will be set to A1B2C3D4F5

continued on next page

wlan.encryption_key4

type: getvar; setvar

This parameter refers to the fourth indexed WEP encryption key. The WEP encryption key is a hexadecimal string that is either 10 or 26 characters long depending on encryption method (40-bit or 128 bit). This key should match the wireless network WEP encryption key 4.

getvar result	This will return the encryption fourth encryption key.	
Example	Description	This command instructs the printer respond with the encryption key value. (This example assumes that the printer is using 40-bit encryption.)
	Syntax Result	! U1 getvar "wlan.encryption_key4" "0000000000"
setvar choices	10 hexadecimal characters for 40-bit encryption 26 hexadecimal character for 128-bit encryption	
	Default	All zeros
Example	Description	This command instructs the printer to set the encryption key value. (This example assumes that the printer is using 40-bit encryption.)
	Syntax	! U1 setvar "wlan.encryption_key4" "A1B2C3D4F5"
	Result	The fourth encryption key will be set to A1B2C3D4F5

wlan.encryption_mode

type: getvar; setvar

This parameter refers to WEP (Wired Equivalent Privacy) encryption. This parameter enables and disables the printer's WEP encryption. When using WEP encryption make sure that the encryption key matches the wireless network WEP encryption key.

NOTE: When using encryption, make sure that the encryption key is set properly. The encryption key and the encryption index should match the encryption key and encryption index of the access point (or the other network devices when in AD HOC mode). When all settings are changed the printer must be wlan.kerberos.mode

getvar result	Returns the type of encryption that is currently being used by the printer.	
Example	Description	Instructs the printer to respond with the encryption value.
	Syntax	! U1 getvar
	Result	"wlan.encryption_mode"
setvar choices	"off", "40-bit", and "128-bit"	
	Default	"off"
Example	Description	This command instructs the printer to turn encryption off.
	Syntax	! U1 setvar "wlan.encryption_mode" "off"
	Result	Sets the encryption mode to off.

continued on next page

wlan.essid

type: getvar; setvar

This parameter refers to the printer's stored eSSID. Setting the eSSID to "" will set the in a "broadcast" mode, where the printer will search for an access point to associate with.

Example: ! U1 setvar "wlan.essid" ""

getvar result	Returns the stored eSSID.	
Example	Description	Instructs the printer to respond with the stored eSSID value.
	Syntax Result	! U1 getvar "wlan.essid" "247"
setvar choices	26 character text string (can be alpha-numeric)	
	Default	"247"
Example	Description	Instructs the printer to set the eSSID to ZebraNet.
	Syntax Result	! U1 setvar "wlan.essid" "ZebraNet" This will set the eSSID to ZebraNet.

wlan.kerberos.kdc

getvar; setvar

This parameter refers to the Kerberos Key Distribution Center (KDC). The KDC is a trusted server which maintains a database with account information for all security principals (users) for a particular site or administrative domain (realm).

getvar result	This will return the current Kerberos KDC.	
Example 1	Description	This command instructs the printer to respond with the current Kerberos KDC.
	Syntax	! U1 getvar "wlan.kerberos.kdc"
	Result	"krbtgt"
setvar choices	0-32 ASCII characters.	
	Default	"krbtgt"
Example 2	Description	This command instructs the printer to set the Kerberos KDC to "krbtgt".
	Syntax	! U1 setvar "wlan.kerberos.kdc" "krbtgt"
	Result	The Kerberos KDC will be set to "krbtgt".

continued on next page

wlan.kerberos.mode

getvar; setvar

This parameter refers to the Kerberos network authentication protocol. Kerberos provides secure mutual authentication for a wireless client through a Symbol Access Point, based on user information stored on a Kerberos KDC (Key Distribution Center) server.

getvar result	This will return the current Kerberos mode.	
Example	Description	This command instructs the printer to respond with the current Kerberos mode.
	Syntax	! U1 getvar "wlan.kerberos.mode"
	Result	"off"
setvar choices	"on", "off"	
	Default	"off"
Example	Description	This command instructs the printer to turn on Kerberos mode.
	Syntax	! U1 setvar "wlan.kerberos.mode" "on"
	Result	This will set the Kerberos mode to "on".

wlan.kerberos.password

getvar; setvar

This parameter refers to the Kerberos password. The password must correspond to a user profile established on the Kerberos KDC server in use.

getvar result	This will return the Kerberos password.	
Example	Description	This command instructs the printer to respond with the current Kerberos password.
	Syntax	! U1 getvar "wlan.kerberos.password"
	Result	"password"
setvar choices	0-32 ASCII characters	
	Default	"password"
Example	Description	This command instructs the printer to set the Kerberos password to "password".
	Syntax	! U1 setvar "wlan.kerberos.password" "password"
	Result	The Kerberos password will be set to "password".

wlan.kerberos.realm

getvar; setvar

This parameter refers to the Kerberos realm, an administrative domain with its own Kerberos server (KDC). Note: realm must be all upper-case if using a Windows 2000 Server.

getvar result	This will return the current Kerberos realm.	
Example	Description	This command instructs the printer to respond with the current Kerberos realm.
	Syntax	! U1 getvar "wlan.kerberos.realm"
	Result	"zebra"
setvar choices	0-64 ASCII characters.	
	Default	"zebra"
Example	Description	This command instructs the printer to set the Kerberos user name to "zebra".
	Syntax	! U1 setvar "wlan.kerberos.realm" "zebra"
	Result	The Kerberos realm will be set to "zebra".

wlan.kerberos.username

getvar; setvar

This parameter refers to the Kerberos user name. The user name must correspond to a user profile established on the Kerberos KDC server in use.

getvar result	This will return the Kerberos user name.	
Example	Description	This command instructs the printer to respond with the current Kerberos user name.
	Syntax	! U1 getvar "wlan.kerberos.username"
	Result	"user"
setvar choices	0-32 ASCII characters.	
	Default	"user"
Example	Description	This command instructs the printer to set the Kerberos user name to "user".
	Syntax	! U1 setvar "wlan.kerberos.username" "user"
	Result	The Kerberos user name will be set to "user".

continued on next page

wlan.leap_mode

type: getvar; setvar

This parameter refers to Cisco LEAP (Lightweight Extensible Authentication Protocol). LEAP provides secure mutual authentication for a wireless client through a Cisco Aironet Access Point, based on user information stored on a backend RADIUS (Remote Authentication in Dial-Up User Service) /AAA (Authentication, Authorization, and Accounting) server.

getvar result	Returns the LEAP mode.	
Example	Description	This command instructs the printer to respond with the LEAP mode.
	Syntax	! U1 getvar "wlan.leap_mode"
	Result	"off"
setvar choices	"on", "off"	
	Default	"off"
Example	Description	This command instructs the printer to turn on LEAP mode.
	Syntax	! U1 setvar "wlan.leap_mode" "on"
	Result	Sets the LEAP mode to "on".

wlan.leap_password

type: getvar; setvar

This parameter refers to the LEAP password. The password must correspond to a user profile established on the RADIUS/AAA server in use.

getvar result	Returns the LEAP password.	
Example	Description	Instructs the printer to respond with the LEAP password.
	Syntax	! U1 getvar "wlan.leap_password"
	Result	"password"
setvar choices	4-32 ASCII characters	
	Default	"password"
Example	Description	Instructs the printer to set the LEAP password to "password".
	Syntax	! U1 setvar "wlan.leap_password" "password"
	Result	The LEAP password will be set to "password".

wlan.leap_username

type: getvar; setvar

This parameter refers to the LEAP user name. The user name must correspond to a user profile established on the RADIUS/AAA server in use.

getvar result	This will return the LEAP user name.	
Example	Description	This command instructs the printer to respond with the LEAP user name.
	Syntax	! U1 getvar "wlan.leap_username"
	Result	"user"
setvar choices	0-32 ASCII characters.	
	Default	"user"
Example	Description	This command instructs the printer to set the LEAP user name to "user".
	Syntax	! U1 setvar "wlan.leap_username" "user"
	Result	The LEAP user name will be set to "user".

continued on next page

wlan.operating_mode

type: getvar; setvar

This parameter refers to the network operating mode. Infrastructure mode means that the printer will try to associate with an access point. Ad hoc mode means that the printer will try to associate with a device other than an access point and join a stand alone network.

To use “ad hoc” mode configure the printer as follows:

- Set the eSSID to the new network’s eSSID.
- Turn off the DHCP and assign an IP Address to the printer.
- Set the Subnet mask on the printer to the new network’s Subnet mask.
- Change the operating mode on the printer to “ad hoc”.

getvar result	Returns the current operating mode.	
Example	Description	Instructs the printer to respond with the value of the network-mode.
	Syntax	! U1 getvar “wlan.operating_mode”
	Result	“infrastructure”
setvar choices	“ad hoc”, “infrastructure”	
	Default	“infrastructure”
Example	Description	This command instructs the printer to change the network-mode to infrastructure.
	Syntax	! U1 setvar “wlan.operating_mode” “infrastructure”
	Result	This will set the printer’s operating mode to infrastructure.

wlan.power_save

type: getvar ; setvar

This parameter refers to the power save modes which affect power consumption of the network radio card in the printer. Two radio cards are currently supported: SYMBOL and CISCO. The SYMBOL radio has a range of power save modes from “1” (best throughput) to “best” (best power save).

The CISCO radio has a fast power save mode and a full power save mode (“best”). Any setting other than “best” (“1”-“4”) sets the radio to fast power save and is not scalable. The “off” setting puts either radio into CAM (Constant Awake Mode).

getvar result	The printer responds with current power save mode setting.	
Example	Description	Instructs the printer to respond with the value of the wlan.power_save mode.
	Syntax	! U1 getvar “wlan.power_save”
	Result	“off”
setvar choices	“off”, “1”, “2”, “3”, “4”, “best”	
	Default	“best”
Example	Description	Instructs the printer to set the value of the power save mode.
	Syntax	! U1 setvar “wlan.power_save” “2”
	Result	Changes the power save mode to “2” if a Symbol radio is used, or fast power save mode if a Cisco radio is used.

wlan.preamble

type: getvar; setvar

This parameter selects the radio preamble length to be used.

getvar result	Current preamble length.	
Example	Description	This command instructs the printer to retrieve the current preamble length.
	Syntax	! U1 getvar "wlan.preamble"
	Result	"long"
setvar choices	"long", "short"	
	Default	"long"
Example	Description	This command instructs the printer to set the authentication type to short.
	Syntax	! U1 setvar "wlan.preamble" "short"
	Result	The preamble length will be set to short after power cycle.

wlan.station_name

type: getvar

This parameter refers to the station name. The station name reported is the printer's serial number.

getvar result	The printer will return its station name. The station name is the printer's serial number.	
Example	Description	Instructs the printer to respond with the value of its station name.
	Syntax	! U1 getvar "wlan.station_name"
	Result	"XXQT02-02-0001"

Zebra QL Printer Mirror Process

Zebra QL printers support a file mirroring process that allows the printer to synchronize files with those stored on an FTP server. Since the process relies solely on the FTP standard, no other special utilities are required. The files on the FTP server can be printer firmware files, fonts, as well as lists of printer configuration commands (such as commands to change the printer's WEP key). In order for this file synchronization process to work properly, it is only required that the FTP server support "Unix style" directory listings and that the modification time stamps of the files stored on the FTP server are accurate.

Printer set up to support mirror process

In order to enable the mirror process on the printer, the following set/get variables are available:

ip.mirror.auto: on/off

If "on", printer will automatically perform a mirror "fetch" command on power-up, and subsequently every "freq" minutes. (see ip.mirror.freq, below)

ip.mirror.username: 20 bytes (string)

Username to use for FTP login

ip.mirror.password: 20 bytes (string)

Password for FTP account

ip.mirror.server: 40 bytes (string)

Server ip address or name (if DNS server info is provided via DHCP).

ip.mirror.path: 50 bytes (string)

Path on the FTP server where the mirror directory is located. Defaults to "companyname/model" (e.g. "/Zebra/QL 320").

NOTE: this must be an absolute path (i.e. it must start with / or ~)

ip.mirror.freq: 0-65535 minutes

Number of minutes to wait before performing another mirror fetch. If this value is "0", the mirror process will only be performed once immediately on power-up. This parameter only applies if

ip.mirror.auto is “on”. Caution should be used if setting a low value - otherwise the printer may spend most of its time performing the mirror process.

ip.mirror.fetch:

Force the mirror process to be run immediately. This variable can be set via SNMP, allowing the mirror process to be triggered via SNMP.

Example of printer configuration for mirror

The following is an example of using the above mirror set/get variables to configure the printer for the mirror process. These commands could be put in a text file and sent to the printer.

```
! U1 setvar "ip.mirror.path" "/Zebra/QL320"  
! U1 setvar "ip.mirror.server" "10.14.4.12"  
! U1 setvar "ip.mirror.freq" "0"  
! U1 setvar "ip.mirror.auto" "on"  
! U1 setvar "ip.mirror.username" "brian"  
! U1 setvar "ip.mirror.password" "password"
```

In the above example, the printer will only perform the mirror process once on power-up, since the “ip.mirror.freq” variable is set to 0.

Server Settings

On the server, the mirror directory structure should look like this:

```
<mirror path>/  
  app/  
  files/  
  commands/
```

App/

App/ will contain only one file - the current printer app. The file name should be the exact printer app name followed by .hex. If the file in the app/ subdirectory is named differently than the current printer version, the printer will download the new application and will automatically re-program itself with this new firmware.

Files/

continued on next page

Files/ will be a flat directory (no subdirectories) that contains all the files that should be installed on the printer. File names must be in 8.3 format. Any new files, or those with more recent time stamps, will be automatically copied to the file system on the printer.

commands/

The commands/ directory will contain files with CPCL commands. (For example, "! U1 setvar "wlan.essid" "myessid".) This will allow the changing of printer settings automatically. Command file names must be in 8.3 format. The time stamp of any files in the commands/ subdirectory will be compared to those of commands which were last executed on the printer. Any command files that have never been run or have a more recent time stamp than those on the printer will be downloaded and executed on the printer.

It may be useful to put a label command in the most recent command file. This will provide visual feedback that the printer successfully performed the mirror process. For example, the following could be the contents of a command file:

```
! U1 setvar "wlan.essid" "myessid"
! U1 setvar "wlan.encryption_mode" "128-
bit"
! U1 setvar "wlan.auth_type" "shared"
! U1 setvar "wlan.encryption_index" "1"
! U1 setvar "wlan.encryption_key1"
"12345678901234567890123456"
! U1 setvar "wlan.encryption_key2"
"23456789012345678901234567"
! U1 setvar "wlan.encryption_key3"
"34567890123456789012345678"
! U1 setvar "wlan.encryption_key4"
"45678901234567890123456789"
! U1 setvar "ip.mirror.auto" "off"
! 0 200 200 240 1
LABEL
PAGE-WIDTH 600
T 0 3 84 17 Network settings updated
FORM
PRINT
```

In this example, after the printer downloads this file and updates its network settings, it will print a label with the text "Network settings updated".

Refer to the following pages for exposition of the ip.mirror variables.

continued on next page

ip.mirror.auto

type: getvar, setvar

This parameter is used to enable or disable the file mirroring process on the printer for the initial power-up sequence and at repeating intervals defined by “ip.mirror.freq”.

getvar result	The current mirror setting.	
Example	Description	Instructs the printer to respond with the value of the FTP mirror mode
	Syntax	!U1 getvar “ip.mirror.auto”
	Result	“off”
setvar choices	“off”: mirror will not be performed automatically “on”: mirror will be performed automatically when the printer is first powered-on and at the interval defined by “ip.mirror.freq”	
	Default	“off”
Example	Description	Enable the mirror process
	Syntax	! U1 setvar “ip.mirror.auto” “on”
	Result	The printer will perform the mirror process on initial power-up and at the repeated interval defined by “ip.mirror.freq”

ip.mirror.fetch

type: do

This command will force the mirror process to be performed immediately.

do choices	Any text string.	
Example	Description	Perform the mirror process
	Syntax	! U1 do “ip.mirror.fetch” “yes”
	Result	The printer will immediately contact the FTP server defined by “ip.mirror.server”, log on with the defined username and password and look for mirror file updates.

ip.mirror.freq

type: getvar; setvar

This parameter defines how frequently (in minutes) the mirror process will be performed.

This parameter only applies if “ip.mirror.auto” is set to “on”.

getvar result	The current mirror frequency in minutes.	
Example	Description	Instructs the printer to respond with the frequency the mirror process is performed.
	Syntax Result	!U1 getvar “ip.mirror.freq” “0”
setvar choices	Any value between “0” and “99”. A value of “0” means the mirror process will only be performed on power-up.	
	Default	“0”
Example	Description	Change mirror frequency to “25”
	Syntax	! U1 setvar “ip.mirror.freq” “25”
	Result	If “ip.mirror.auto” is “on”, then the mirror process will be performed on initial power-up and every 25 minutes thereafter.

continued on next page

ip.mirror.password

type: getvar; setvar

This parameter defines FTP password that will be used for the mirror process.

getvar result	The current mirror password – masked with asterisks.	
Example	Description	Instructs the printer to respond with the value of the FTP password
	Syntax	!U1 getvar "ip.mirror.password"
	Result	*****!
setvar choices	Any text string up to 20 characters in length	
	Default	"password"
Example	Description	Change mirror password to "secret"
	Syntax	! U1 setvar "ip.mirror.password" "secret"
	Result	The next time the mirror process is performed, the printer will use the FTP password "secret".

ip.mirror.path

type: getvar; setvar

This parameter defines the path on the FTP where the mirror directories are located. This can be a relative path based on the FTP username or an absolute path based on the FTP root directory.

getvar result	The current mirror path.	
Example	Description	Instructs the printer to respond with the FTP path to the mirror directories.
	Syntax	!U1 getvar "ip.mirror.path"
	Result	"Zebra/QL 320"
setvar choices	Any text string up to 50 characters in length.	
	Default	"Zebra/QL 320"
Example	Description	Change mirror path to "zebra/ql"
	Syntax	! U1 setvar "ip.mirror.path" "zebra/ql"
	Result	The next time the mirror process is performed, the printer will look for the updates in the "zebra/ql" relative directory.

ip.mirror.server

type: getvar; setvar

This parameter defines the FTP server that will be used for the mirror process.

getvar result	The current mirror server address	
Example	Description	Instructs the printer to respond with the FTP server used for the mirror process
	Syntax Result	!U1 getvar "ip.mirror.server" "0.0.0.0"
setvar choices	Either an IP address or any DNS resolvable name up to 40 characters in length	
	Default	"0.0.0.0"
Example	Description	Change mirror server to "192.168.1.1"
	Syntax	! U1 setvar "ip.mirror.server" "192.168.1.1"
	Result	The next time the mirror process is performed, the printer will connect to the FTP server at address 192.168.1.1.

ip.mirror.username

type: getvar; setvar

This parameter defines FTP username that will be used for the mirror process.

getvar result	The current username.	
Example	Description	Instructs the printer to respond with the value of the FTP user name
	Syntax Result	!U1 getvar "ip.mirror.username" "username"
setvar choices	Any text string up to 20 characters in length	
	Default	"username"
Example	Description	Change mirror username to "test"
	Syntax	! U1 setvar "ip.mirror.username" "test"
	Result	The next time the mirror process is performed, the printer will use the FTP username "test".

Virtual Privacy Network (VPN) Commands

A Virtual Privacy Network (VPN) allows users in remote locations to “log in” securely onto a network and use it as though they were logged-in locally.

If you “enable VPN” by setting the parameter “ip.vpn.mode” to anything but “OFF”, and have the appropriate VPN (Virtual Private Network) setup on your network, you can ensure that the wireless portion of the network is highly secure. Basically any wireless network traffic going to and from the printer goes through the VPN server where it gets encrypted.

The following parameters configure the printer for use on a VPN:

ip.vpn.addr

type: getvar

This is the virtual IP address of the printer that is assigned by the VPN server

getvar result	Returns the virtual IP address of the printer	
Example	Description	Get the virtual VPN address.
	Syntax	! U1 getvar “ip.vpn.addr”
	Result	“0.0.0.0”

ip.vpn.domain

Type: getvar; setvar

Obtain or change the domain name of the VPN server you are connecting to.

getvar result	Returns the stored domain	
Example	Description	Obtain the VPN domain name
	Syntax	! U1 getvar "ip.vpn.domain"
	Result	"mydomain"
setvar choices	Length must be between 1-64 characters	
	Default	"mydomain"
Example	Description	Change the VPN domain to "domain2"
	Syntax	! U1 setvar "ip.vpn.domain" "domain2"
	Result	VPN domain name is "domain2"

ip.vpn.mode

type: getvar; setvar

This parameter activates the VPN function and allows you to select the type of VPN server you are connecting to. At present the only type of VPN server supported is AIRBEAM.

getvar result	Returns the VPN mode	
Example	Description	Obtain the VPN mode
	Syntax	! U1 getvar "ip.vpn.mode"
	Result	"OFF"
setvar choices	"OFF", "AIRBEAM SAFE"	
	Default	"OFF"
Example	Description	Change the vpn mode to "AIRBEAM SAFE"
	Syntax	! U1 setvar "ip.vpn.mode" "AIRBEAM SAFE"
	Result	VPN mode is now set to "AIRBEAM SAFE"

ip.vpn.password

type: getvar; setvar

Obtains or changes the password required to log-on to the VPN server

getvar result	Returns "****" representing the stored VPN password	
Example	Description	obtain the VPN password
	Syntax	! U1 getvar "ip.vpn.password"
	Result	Returns "password"
setvar choices	Length must be between 1-32 characters	
	Default	"password"
Example	Description	Change the VPN password to "secret"
	Syntax	! U1 setvar "ip.vpn.password" "secret"
	Result	VPN password now set to "secret"

ip.vpn.username

type: getvar; setvar

Obtains or changes the username that allows access to the VPN server

getvar result	Gets the stored username	
Example	Description	Obtain the current VPN username
	Syntax	! U1 getvar "ip.vpn.username"
	Result	Returns "user"
setvar choices	Length must be between 1-32 characters	
	Default	"user"
Example	Description	Change the VPN username to "Zebrauser"
	Syntax	! U1 setvar "ip.vpn.username" "Zebrauser"
	Result	VPN username is now set to "Zebrauser"

PRINTER CONFIGURATION AND SETUP

MINIATURE PRINTER UTILITIES PROGRAM

The Miniature Printer Utilities program, available on a floppy disk (part number DISK-MP) for DOS and Windows, is available from Zebra.

The MP Utilities (MPU) allow the user to:

1. Reprogram the printer.
2. Read printer status
3. Set printer parameters, such as:
 - Baud Rate
 - Inactivity Timeout
 - User Label Count
 - Enable/Disable DTR Power off
 - Enable XON/XOFF Mode
4. Print test labels

To run MPU from DOS, execute the program directly from disk or copy files to a sub-directory on your hard drive, then type MENU.

For Windows, type SETUP from Program Manager. A program group and icon will be created.

Before reprogramming printer, utilize Option 2 - Read Printer Status, to verify communication settings (baud rate, etc.). To reprogram printer for installation of Bar Code/Font/Command files, turn printer on and install media. The Error LED flashes until the file is successfully written into nonvolatile memory. When error LED extinguishes, the printer prints a report of version numbers and available fonts.

MP UTILITIES PROGRAM (continued)

If your printer does not already include MaxiCode or PDF417 , it is necessary to load either of these bar codes into Flash Memory.

TO REPROGRAM PRINTER FLASH:

1. Type "Menu" from MPU Program .
2. Select appropriate COM Port and Baud Rate:
1 = COM1 19,200 3 = COM1 9600
2 = COM2 19,200 4 = COM2 9600
3. Verify PC to printer communication by selecting option #2 (Read Printer Status).
4. Press Enter to continue.
5. Select Option #1 (Reprogram Printer) from Main Menu.
6. Prompt will ask "Please enter file name:". Type in the appropriate hex file name. % indicator will display percentage of reprogramming progress.
7. When programming is complete, printer will print out "Reprogrammed successful" message.
8. Press Enter to continue.
9. Turn printer Off then On again.

Printer is now reprogrammed. It is recommended to now select #4 (Print Test Labels) and enter ????.LBL file to test printer.

MP UTILITIES PROGRAM (continued)

To load UPS MaxiCode, follow the procedure described in the previous section up to step 5. Select Option 1 and enter MPUPSXX.HEX at the prompt for file name. The printer is now programmed with all the standard fonts, bar code symbologies and UPS MaxiCode.

To load PDF417 symbology, follow the same procedure for UPS Maxicode, but instead send the MPPDFXX.HEX file. The printer is now programmed with all the standard fonts, bar code symbologies and PDF417.

Using Label Vista to Send Files



The Label Vista label creation application can also be used to re-configure the printer by sending new application, font or .bat files to the printer. The Label Vista utilities are located under the Printer Menu.

You should first establish communications between your printer and a PC running label vista by using the **Com Port Setup** menu detailed below:

Port Sets up the communications port via the ComPort dialog box. The user may select from several different methods of communicating with the printer and select the rate at which data is transferred.. The **Com1** or **Com2** selections allow bi-directional serial communications with the printer.

Note: The LPT1 write/COM1 read or LPT1 write/COM2 read options are only used with the Bravo series of desk top printers.

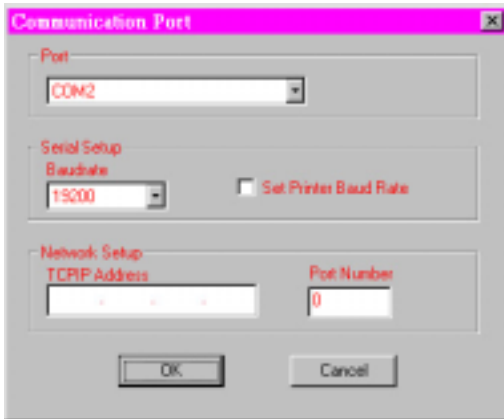

Two network protocols are available to talk to Zebra printers equipped with wireless network capabilities: **NETWORK TCPIP** and **NETWORK LPD**. In order to communicate with the printer, choose the protocol that the

printer is configured for. If you are unsure as to which protocol the printer is setup for, turn the printer off and while holding the feed key down turn the printer back on. This will print the printer's 2-key report. The protocol that the printer is configured to use is listed under the RF-LAN section. If the printer is using a Symbol MOM card choose the NETWORK SYMBOL MOM CARD option. This is a TCP protocol that does not close the network connection.

In order to talk to a network printer the IP address and port must also be entered. The printer's current IP address and port are also listed on the 2-key report.

Baudrate allows selection of the rate at which data is sent over either COM port. Baud rates range from 2400 to 115200 b.p.s.

Checking the **Set Printer Baud Rate** box allows Label Vista to automatically set the Baud rate for the program and the printer.

Once Communications have been established between Label Vista and the printer you can send files to the printer with the various "Send" options:.

1 Send File

Downloads a file to the printer. Clicking on the "Browse" button allows the user to select a file to be downloaded via the standard Windows interface. A bar at the bottom of the dialog box monitors downloading process. This interface is common to all of the file download utilities.

2 Send Font

Downloads a font file (.CSF, .CPF extensions) to the printer. (Refer to the Fonts Menu selection for more information.)

3 Send Picture

Downloads a picture file (.PCX) to the printer. Note: Any picture file placed in the label with the Picture tool must also be downloaded to the printer by means of this command.

4 Send Autoexec.

Downloads an autoexec.bat file to the printer. If a .lbl type file is downloaded using this command, It will be converted from an .lbl file into an autoexec.bat type file. The printer will execute this file on power up (i.e. print the label described in the file).

5 Send as Run.bat

Sends either a label or a format file to the printer as a RUN.BAT file. Upon power up, and after running any resident AUTOEXEC.BAT files, the printer will automatically execute a RUN.BAT file.

6 Send as FF.BAT

Sends a selected label file to the printer as a FF.BAT file. The printer will automatically execute a FF.BAT file whenever its "Feed" key is pressed.

7 Send all Files in Label

This command will send all fonts and pictures associated with the current label file to the printer. There must be sufficient memory in the printer to accept all of the files, and they must all be located in the current Label Vista working directory.

8 Diagnostic Send

Downloads a file without checking for status or validity. This function is usually used when the printer has been placed in the Communications Diagnostics Mode. Refer to Section 1 of this manual for complete information on utilizing the Communications Diagnostic Mode.

Label Vista has an extensive set of context-sensitive help files which will aid you in using the various file utilities available.

POWER MANAGEMENT

The printer contains the following power management features:

1. Synchronized On/Off control via DTR line from the attached host (DTR On/Off Control).
2. Programmable inactivity timeout.
3. Programmable low-battery timeout.
4. Shutdown command.
5. Enters low-power mode when idle.

SYNCHRONIZED ON/OFF CONTROL VIA PRINTER'S DSR LINE

The DSR line is an input to the printer and is controlled by the attached host's DTR line. The DSR line controls the power on/off and the operation of the short-range radio module.

1.Power On/Off Control

A low (inactive) to high (active) transition on this line will cause the printer to turn ON. A high (active) to (low) transition on this line will cause the printer to turn OFF only if it is configured to do so. The factory default configuration enables power-off on high to low transition on DSR. This setting can be changed using the MP Utilities program.

The printer will stay ON for as long as DSR is high (active) unless it reaches low-battery shut down point, or it receives a command to shut down. Please note that the inactivity time-out is disabled while DSR is high (active).

NOTE: When the DSR line goes high, a delay of 500 ms must be observed prior to sending data to the printer. This delay allows the printer ample time to initialize. Handshaking protocol (i.e. RTS/CTS or Xon/Xoff) must be used to prevent missed characters.

POWER MANAGEMENT (continued)

2.Short-Range Radio Control

The short range radio is enabled when DSR line is low (inactive) or when the host-to-printer cable is disconnected. In this case, the printer will attempt to communicate to the host over the short-range radio if the printer is so equipped. In its active (high) state, the DSR line will disable the short-range radio, if any, and will communicate over the RX/TX line of the serial port. For printers that are not equipped with a short-range radio, the host terminal must still keep the DSR line at an active state.

The printer can be programmed to time-out, and shut itself off, upon reaching a predefined inactivity period. The factory default inactivity time-out is 2 minutes. This setting can be changed using the MP Utilities program , the Label Vista application or by sending the following command to the printer.

```
! UTILITIES  
TIMEOUT n  
END
```

Where n is the inactivity timeout in 1/8 of a second. For example, n=960 for a 2 minute inactivity timeout (120 seconds X 8).

A timeout of 0 disables inactivity timeout.

PROGRAMMABLE LOW-BATTERY TIMEOUT

The printer can be programmed to timeout, and shut itself off, upon reaching a predefined period after low battery condition is detected. The factory default low battery timeout is 1 minute. This setting can be changed using the MP Utilities program or the Label Vista application.

POWER MANAGEMENT (continued)

SHUTTING OFF THE PRINTER REMOTELY

The printer can be turned off by sending the following shut down command:

Off Command ESC (0x1b) 'p' (0x70)

This function can be used instead of lowering DTR causing the printer to shut down.

ENTERING LOW-POWER MODE WHEN IDLE

The printer automatically enters low-power mode when it is idle in order to conserve power. All resident data and images will be preserved while the printer is in low-power mode.

BATCH FILES

The printer flash file system can be used to store a start-up file titled AUTOEXEC.BAT. When the printer is powered on, this file will be searched for and, if present, the printer will execute the commands found in this file. The following example shows how to create an AUTOEXEC.BAT file and load it into the printer.

```
! DF AUTOEXEC.BAT
! UTILITIES
SETLP 5 1 40
PRINT
```

Line one uses the (D)efine (F)ile command to label this file as AUTOEXEC.BAT. The end of an AUTOEXEC.BAT file is indicated by a PRINT command as shown in line four.

When this file is executed, the printer will select font number 5, size 0 as the default front for line printer mode, and the printer will advance 40 dots for every carriage-return (0x0d) received.

Note: Every time a file is created on the printer by using the "! DEFINE-FORMAT..." or "! DF..." the file information is written to flash memory. Unlike RAM, flash memory does not require battery power for retaining data, and is immune to data corruption due to static discharge. Although flash memory is superior to RAM for safeguarding file contents, it is limited to an average of 10,000 write cycles (i.e. file creations). The user should use the file creation commands only when needed to ensure this write cycle limit is not exceeded.

RUN.BAT Command/File

The printer will execute the RUN.BAT file on power-up, if one exists. This file may be a format or label file. The only time RUN.BAT file is not executed is after a two-key reset (hold feed key down, turn printer on, release feed key when printer starts printing).

The following example demonstrates the use of the RUN.BAT file for an application that uses a bar code scanner connected to the printer's serial port for data input. The scanner must be set to the same baud rate as the printer, and be configured for 8 data bits, 1 stop bit, no parity. Scanned data must be terminated with both carriage return and line feed (0x0D 0x0A) characters.

The following RUN.BAT file is first sent to the printer's flash file system. When the printer is turned ON this file is found and executed. The keyword RE-RUN is used in the file to instruct the printer to execute this file repeatedly. In this case, the BARCODE command data will be taken from the serial input.

The printer will produce a label each time a bar code is scanned.

RUN.BAT Example

Input (RUN.LBL):

```
! DF RUN.BAT
! 0 200 200 210 1
CENTER
BARCODE-TEXT 7 0 5
BARCODE 128 1 1 50 0 90 \\
RE-RUN
FORM
PRINT
```

Input from scanner (SCANRUN.LBL)

Output:



RE-RUN Command

The RE-RUN command instructs the printer to execute the current file after an end-of-file is encountered. Any format or command file in the printer, with the exception of AUTOEXEC.BAT and CONFIG.SYS, may use the RE-RUN command.

GAP-SENSE & BAR-SENSE Commands

These commands are used to instruct the printer as to which means of top-of-form detection should be employed. Printers default to BAR-SENSE if no command is specified. Printers that are not equipped with a gap-sensor will attempt a pseudo gap-sense.

Format:

{command}

where:

{command}: Choose one of the following:

GAP-SENSE # (0-255)

BAR-SENSE # (0-255)

Gap and Bar Sense commands can be followed by a number to adjust sensitivity. This is useful for gap sense stock from vendors other than Zebra.

GAP-SENSE Command Example:

The following example configures the printer for gap-sensing. In addition, it specifies that the distance from top-of-form to the gap is zero.

```
Input (GAPSENSE.LBL):
```

```
! UTILITIES
GAP-SENSE
SET-TOF 0
PRINT
```

Index

INDEX

Symbols

! U1 Command. *See* UTILITIES Command
.cpf files. *See* fonts: pre-scaled

A

Accessories CD P1-1
Acknowledge Printer Reset P11-3. *See also* Printer Escape Commands
Advanced Control Commands P8-1
Advanced Utilities
 examples P10-1
ALL CHRS.LBL P1-7
ANNOUNCE Command P10-12
AUTOEXEC.BAT P9-2, P10-37, P15-10

B

Backspace P9-10
BAR-SENSE Command P9-10, P15-13
BARCODE Command P5-16, P9-15
BARCODE-TEXT P5-18, P6-5
Barcodes, standard
 samples P5-2
BATCH FILES P15-10. *See also* AUTOEXEC.BAT
BAUD Command P10-9
BEEP Command P8-27, P10-15
BHT MODE Commands P10-48
 COUNTED STRING P10-48
 RAW P10-48
 STRIP-ADD-CRLF P10-48
 STRIP-SPACES P10-48
BHT PROTOCOL Command P10-52
 BHT Mode P10-52
 BHTIR Mode P10-52
 CABLE Mode P10-52
BHT Terminal P10-37
 configuring for cable communications P10-42
BHT-BAUD command P10-39, P10-47
BHT-PROTOCOL Command P10-39
BlueTooth commands
 using set/get/do parameters P14-5
BOX command P7-1

INDEX (continued)

C

CENTER. *See* Justification Commands
CHECKSUM P10-3. *See also* Advanced Utilities
Checksum calculation,
 Codabar P5-11
 Code 128 P5-10
 Code 39 P5-6
 Code 93 P5-8
 Postnet P5-13
 UPC/EAN P5-4
Codabar barcode P5-11
Code 128 barcode P5-9
Code 39 barcode P5-6
Code 93 barcode P5-8
Comments P2-8
Communications Diagnostics P1-7
COMPRESSED-GRAPHICS Command. *See* Graphics Commands
CONCAT P3-8. *See* TEXT Concatenation Commands
CONTRAST Command P8-1
COUNT command P3-12, P5-20
COUNTRY Command P8-22, P10-10
CUT Command P8-28, P9-15
CUT-AT Command P8-30, P9-14

D

Date stamp
 Printing P10-23
DEFINE-FORMAT. *See* Format File Commands
DEL P10-4. *See also* Advanced Utilities
Denso Barcode Handy Terminal. *See* BHT Terminal
DF Command P10-6
DIR P10-5. *See also* Advanced Utilities
do Command P14-2
do parameters
 device.reset P14-13
 device.restore_defaults P14-14
 file.delete P14-17
 file.print P14-17
 file.rename P14-18
 file.run P14-18
 file.type P14-18
 ip.mirror.fetch P14-82

- ip.ping_remote P14-45
- ip.snmp.create_mib P14-57
- test.print_diags P14-36
- test.report_diags P14-36

E

Error messages

- LAN P12-8

EXPANDED-GRAPHICS. *See* Graphics Commands

F

Facing Identification Mark (FIM) P5-13

FEED. *See* ON-FEED Command

FG command P3-6

file mirroring P14-78

- printer set up P14-78

- server settings P14-79

Flash Memory P8-26

Font

- monospaced P9-17

- TrueType™ P9-4

Font group. *See* FG command

fonts

- pre-scaled P1-9

FORM command P2-4

Form Feed P9-10

Format File Commands P1-9, P8-24, P8-25, P8-26

G

GAP-SENSE Command P9-10, P15-13

German Post Code. *See* Interleaved 2 of 5 barcode: German Post Code

Get Extended Printer Status P11-4, P14-26

Get Printer Information P11-4. *See also* Printer Escape Commands

Get Printer Status P11-3. *See also* Printer Escape Commands

GET-DATE command P10-21

GET-TIME command P10-19

getvar Command P14-2

getvar parameters

- appl.date P14-4

- appl.name P14-4

- appl.version P14-4

- bluetooth.address P14-5

- bluetooth.authentication P14-6

INDEX (continued)

bluetooth.baud P14-8
bluetooth.bluetooth_pin P14-7
bluetooth.discoverable P14-8
bluetooth.friendly_name P14-9
bluetooth.local_name P14-9
bluetooth.version P14-10
card.mac_addr P14-37
comm.baud P14-11
comm.parity P14-11
comm.stop_bits P14-12
device.friendly_name P14-13
display.backlight P14-15
display.contrast P14-15
display.text P14-16
file.dir P14-17
head.latch P14-19
input.capture P14-22
ip.addr P14-37
ip.bootp.enable P14-38
ip.dhcp.cid_prefix P14-40
ip.dhcp.cid_type P14-41
ip.dhcp.cid_value P14-42
ip.dhcp.enable P14-39
ip.ftp.enable P14-43
ip.gateway P14-43
ip.http.enable P14-44
ip.lpd.enable P14-44
ip.mirror.auto P14-82
ip.mirror.freq P14-83
ip.mirror.password P14-84
ip.mirror.path P14-84
ip.mirror.server P14-85
ip.mirror.username P14-85
ip.netmask P14-45
ip.pop3.enable P14-46, P14-47, P14-48, P14-49, P14-50
ip.pop3.password P14-46
ip.pop3.poll P14-47
ip.pop3.print_body P14-48
ip.pop3.print_headers P14-48, P14-50
ip.pop3.save_attachments P14-49
ip.pop3.server_addr P14-49
ip.pop3.username P14-50
ip.pop3.verbose_headers P14-50

ip.port P14-51
ip.remote P14-51
ip.remote_autoconnect P14-52
ip.remote_port P14-53
ip.smtp.enable P14-53
ip.smtp.server_addr P14-54
ip.snmp.enable P14-54
ip.snmp.get_community_name P14-55
ip.snmp.set_community_name P14-56
ip.tcp.enable P14-57
ip.telnet.enable P14-58
ip.udp.enable P14-58
ip.vpn.addr P14-86
ip.vpn.domain P14-87
ip.vpn.mode P14-87
ip.vpn.password P14-88
ip.vpn.username P14-88
media.sense_mode P14-24
media.status P14-24
media.tof P14-25
media.type P14-26
media.width_sense.enable P14-19
media.width_sense.in_cm P14-20
media.width_sense.in_dots P14-21
media.width_sense.in_inches P14-21
media.width_sense.in_mm P14-20
memory.flash_free P14-27
memory.flash_size P14-27
memory.ram_free P14-27
memory.ram_size P14-27
odometer.label_dot_length P14-28
odometer.latch_open_count P14-29
odometer.media_marker_count P14-30
odometer.user_label_count P14-31
power.ascii_graph P14-32
power.dtr_power_off P14-32
power.inactivity_timeout P14-33
power.low_battery_shutdown P14-34
power.low_battery_timeout P14-33
power.low_battery_warning P14-34
power.percent_full P14-34
power.status P14-34
power.voltage P14-35
test.feed P14-36

INDEX (continued)

wlan.associated P14-59
wlan.auth_type P14-59
wlan.current_essid P14-60
wlan.current_tx_rate P14-60
wlan.encryption_index P14-61
wlan.encryption_key1 P14-62
wlan.encryption_key2 P14-63
wlan.encryption_key3 P14-64
wlan.encryption_key4 P14-65
wlan.encryption_mode P14-66
wlan.essid P14-67
wlan.kerberos.kdc P14-68
wlan.kerberos.mode P14-66, P14-69
wlan.kerberos.password P14-70
wlan.kerberos.realm P14-71
wlan.kerberos.username P14-72
wlan.leap_mode P14-73
wlan.leap_password P14-74
wlan.leap_username P14-74
wlan.operating_mode P14-60, P14-75
wlan.power_save P14-76
wlan.preamble P14-77
wlan.station_name P14-77
Graphics Commands P7-1, P7-8

I

IGNORE. *See* ON-FEED Command
IN-CENTIMETERS. *See* Units Utility Commands
IN-DOTS. *See* Units Utility Commands
IN-INCHES. *See* Units Utility Commands
IN-MILLIMETERS. *See* Units Utility Commands
Interleaved 2 of 5 barcode P5-8
 German Post Code P5-9
INVERSE-LINE command P7-4

J

JOURNAL Command P14-26
JOURNAL command P2-5
Justification Commands P8-3, P9-15

L

Label Coordinate System P1-8
Label Height P1-3

- Label Height
 - maximum P2-2
- Label Vista P1-9, P5-1, P9-4, P9-16, P13-1, P15-4
- LAN Command P12-1. *See also* Network Printers error messages. *See* Error messages: LAN
 - gateway IP address
 - setting P12-2
 - getting configuration settings P12-4
 - getting status of P12-3
 - hard resetting WLAN card P12-5
 - IP address P12-2, P12-5, P12-7
 - obtaining P12-6
 - saving P12-6
 - Mode setting
 - LPD P12-3, P12-7
 - TPC P12-3
 - Remote IP address
 - setting P12-2
 - soft resetting WLAN card P12-5
 - SSID setting P12-3, P12-7
 - subnet mask
 - setting P12-3
 - TCP port
 - setting P12-6
- Language
 - programminmg
 - CPCL P1-1
 - EPL II P1-1
 - ZPL P1-1
- LEFT. *See* Justification Commands
- LINE command P7-2
- line print mode P9-1, P11-1
- Line-terminator characters P10-17
- LMARGIN Command P9-7
- Low-Battery Timeout P15-8. *See* POWER MANAGEMENT
- Low-Power Mode P15-9
- LT command P10-17

M

- MaxiCode P6-2, P6-6
 - downlading to printer P15-3
 - encoded tags P6-6–P6-8
 - publication: Guide to bar Coding P6-8
- MCR Command P8-31, P10-24

INDEX (continued)

- Data Reporting Options P10-26
- Debugging Options P10-26
- Error Reporting Options P10-28
- Frequency Options P10-25
- Track Data Transmit Options P10-26
- Track Options P10-25
- MCR-CAN Command P10-32
- MCR-QUERY Command P10-30
- Messages, resident P10-12. *See also* ANNOUNCE Command
- Miniature Printer Utilities Program P15-1
- MSI Plessey barcode P5-12
- MULTILINE Commands P3-10

N

- Network Printers P12-1. *See also* LAN Command
 - QL series
 - FTP sessions P13-1
 - safety considerations P12-1
 - setting IP address P12-7
 - WLAN operating modes
 - infrastructure mode P14-75
 - WILAN operating modes,
 - ad hoc mode P14-75
- Networking commands
 - using set/get/do parameters P14-37
- NO_PACE Command P8-9
- NW7 barcode P5-12

O

- Odometer Parameters P14-28
- Off Command P15-9
- ON-FEED Command P8-16
- ON-OUT-OF-PAPER Command P8-15

P

- PACE Command P8-6
- PAGE-HEIGHT Command P9-10
- PAGE-WIDTH Command P8-4, P9-7, P9-10
- Paper supply status. *See* Get Extended Printer Status
- PARTIAL-CUT Command P8-29, P9-15. *See also* CUT-AT Command
- PATTERN command P7-6

PCX Command P7-10, P9-15. *See also* Graphics Commands
PDF (Portable Data File) Bar Code. *See* Two Dimensional Barcode
Commands
PDF417 Barcode P6-2
 downloading to printer P15-3
Plus 2 & plus 5 extensions. *See* UPC and EAN/JAN barcodes
POST-TENSION. *See* TENSION Commands
POSTFEED Command P8-19
Postnet barcode P5-13
 USPS Publication 25 P5-14
Power Management P15-7
 and Short-Range Radio Control P15-8
 Off Command P11-5. *See also* Printer Escape Commands
 using DSR P15-7
Power On/Off Control. *See* Power Management
PRE-TENSION. *See* TENSION Commands
PREFEED Command P8-18
PRESENT-AT Command P8-20, P9-14
Presentation(peeler) sensor. *See* Get Extended Printer Status
PRINT command P2-3
Printer Configuration and Setup P15-1
Printer Control Commands P2-2
Printer Escape Commands P11-1, P11-2
Printer Information P1-3
Programming Language Emulation P1-1
 recommended use of P1-2

Q

QL series printers
 LCD control panel P13-1

R

RE-RUN command P15-12
READCCL.LBL P11-1
REPRINT. *See* ON-FEED Command
REWIND Command P8-11
REWIND-OFF. *See* REWIND Command
REWIND-ON. *See* REWIND Command
Ribbon status. *See* Get Extended Printer Status
RIGHT. *See* Justification Commands
ROTATE Commands P4-8
RUN.BAT Command P15-11

INDEX (continued)

S

- S-CARD Command P10-33
- Scalable Concatenation Commands P3-8, P4-6
- SCALE TO FIT Commands P4-4
- SCALE-TEXT Commands P4-2
- SET-DATE command P10-20
- SET-TIME command P10-18
- SET-TOF Command P9-12, P14-25
- set/get/do commands P14-1
 - Bluetooth parameters P14-5
 - networking parameters P14-37
- SETBOLD Command P9-8
- SETCCL.LBL P11-1
- SETFF Command P2-4, P9-11
- SETLF Command P9-5
- SETLP. *See* SETLP command
- SETLP Command P9-4
- SETLP-TIMEOUT Command P9-16
- SETMAG command P3-14
- SETSP Command P8-14, P9-9
- setvar Command P14-2
- setvar parameters
 - bluetooth.authentication P14-6
 - bluetooth.bluetooth_pin P14-7
 - bluetooth.discoverable P14-8
 - bluetooth.friendly_name P14-9
 - comm.baud P14-11
 - comm.parity P14-11
 - comm.stop_bits P14-12
 - device.friendly_name P14-13
 - display.backlight P14-15
 - display.contrast P14-15
 - display.text P14-16
 - input.capture P14-22
 - ip.addr P14-37
 - ip.bootp.enable P14-38
 - ip.dhcp.cid_prefix P14-40
 - ip.dhcp.cid_type P14-41
 - ip.dhcp.cid_value P14-42
 - ip.dhcp.enable P14-39
 - ip.ftp.enable P14-43
 - ip.gateway P14-43

ip.http.enable P14-44
ip.lpd.enable P14-44
ip.mirror.auto P14-82
ip.mirror.freq P14-83
ip.mirror.password P14-84
ip.mirror.path P14-84
ip.mirror.server P14-85
ip.mirror.username P14-85
ip.netmask P14-45
ip.pop3.enable P14-46, P14-48, P14-49, P14-50
ip.pop3.password P14-46
ip.pop3.poll P14-47
ip.pop3.print_body P14-48
ip.pop3.print_headers P14-48, P14-50
ip.pop3.save_attachments P14-49
ip.pop3.server_addr P14-49
ip.pop3.username P14-50
ip.pop3.verbose_headers P14-50
ip.port P14-51
ip.remote P14-51
ip.remote_autoconnect P14-52
ip.remote_port P14-53
ip.smtp.enable P14-53
ip.smtp.server_addr P14-54
ip.snmp.enable P14-54
ip.snmp.get_community_name P14-55
ip.snmp.set_community_name P14-56
ip.tcp.enable P14-57
ip.telnet.enable P14-58
ip.udp.enable P14-58
ip.vpn.domain P14-87
ip.vpn.mode P14-87
ip.vpn.username P14-88
media.sense_mode P14-24
media.tof P14-25
media.type P14-26
media.width_sense.enable P14-19
odometer.latch_open_count P14-29
odometer.media_marker_count P14-30
odometer.user_label_count P14-31
power.dtr_power_off P14-32
power.inactivity_timeout P14-33
power.low_battery_timeout P14-33
wlan.auth_type P14-59
wlan.encryption_index P14-61

INDEX (continued)

- wlan.encryption_key1 P14-62
- wlan.encryption_key2 P14-63
- wlan.encryption_key3 P14-64
- wlan.encryption_key4 P14-65
- wlan.encryption_mode P14-66
- wlan.essid P14-67
- wlan.kerberos.kdc P14-68
- wlan.kerberos.mode P14-66, P14-69
- wlan.kerberos.password P14-70
- wlan.kerberos.realm P14-71
- wlan.kerberos.username P14-72
- wlan.leap_mode P14-73
- wlan.leap_password P14-74
- wlan.leap_username P14-74
- wlan.operating_mode P14-75
- wlan.power_save P14-76
- wlan.preamble P14-77

Short-Range Radio Control. *See* POWER MANAGEMENT

SmartCard reader. *See* S-CARD command

software version, ascertaining P14-1

SPEED Command P8-13

Synchronized On/Off Control P15-7

T

TENSION Commands P8-12

TEXT Command P3-4, P6-5

Text Concatenation Commands P3-8, P4-6

Time stamp

- Printing P10-22

TIMEOUT Command P10-14

TONE Command P8-2

top-of-form. *See* SET-TOF Command. *See* SET-TOF Command

Two Dimensional Barcode Commands P6-1

two-key reset. *See* Printer Information

TYPE P10-8. *See also* Advanced Utilities

U

UCC-128 Shipping Standard P5-10

Units Commands P2-6, P9-3, P9-8

UPC and EAN/JAN barcodes

- number system character P5-3

- Plus2 and Plus 5 Extensions P5-5

UPC-E barcode P5-4
USE-FORMAT. *See* Format File Commands
UTILITIES Command P9-2

V

VBARCODE. *See* BARCODE command
VCOMPRESSED-GRAPHICS Command. *See* Graphics Commands
VCONCAT P3-8. *See* TEXT Concatenation Commands
VERSION P10-2. *See also* Advanced Utilities
VEXPANDED-GRAPHICS Command. *See* Graphics Commands
Virtual Privacy Network Commands P14-86
VPN. *See* Virtual Privacy Network Commands
VSCALE-TEXT. *See* SCALE-TEXT Commands
VSCALE-TO-FIT. *See* SCALE TO FIT Commands

W

WAIT Command P8-10
Wireless Network Printers. *See* Network Printers
WML language P13-1
 tags used for LCD display P13-7

X

X and Y Values,
 moving with P9-6

Appendices

APPENDIX A-Frequently Asked Questions

These FAQ's are in no particular order. They cover the most commonly encountered questions asked about our portable printers.

- Q.** *The first label I print is fine, but the next one starts printing not as close to the top of the label form, then sometimes skips a label, then prints a good label.*
- A.** Make sure that you only have one carriage return/line feed pair after the PRINT statement in your label. If there is more than one CR/LF pair, the printer prints the label, then sees the extra CR/LF pairs as data to be printed in line print mode. This advance causes the next label to be registered incorrectly when a new label file is sent.
- Q.** *I send a label to the printer, and the label begins to print. Before all of the label is printed, there is a feed to the next label. This happens for 2 attempts before the printer stops.*
- A.** Make sure that the label length specified in your command line is shorter than the distance between your eye sense marks on the label stock. If you are asking to print, say a 400 dot long label and the label stock eye sense marks are 300 dots apart, the printer 'sees' an eye sense mark before the entire label has printed and assumes the label stock was not at top of form. It then feeds to the next top of form and tries again. After 2 tries, the printer advances to the next top of form and stops.
- Q.** *When I send a label to the printer, the label file gets printed, and not the label itself.*

APPENDIX A (continued)

- A.** If you are getting the label file printed instead of the label, the syntax of the first line may be incorrect. Check that the syntax is something like: ! 0 200 200 210 1 where the 210 is the label length and 1 is the quantity. If the printer detects an invalid first line, the command mode is not entered. Instead, the printer acts as a generic line printer, and the remaining lines are treated as raw text to be printed.
- Q.** *My printer doesn't seem to respond when I send anything to it.*
- A.** Make sure that you have the same communications parameters for both the printer and the device connected to it. You can determine the printer's settings by turning the printer off, then while holding the feed key down, turning the printer back on. It should respond by printing a report, pause for about 3 seconds, then print a second report. If you look through these reports, you will find an entry for the current baud rate setting. A good progression for finding problems like this is to use the MPU.EXE utility. Connect the cable, then turn the printer off. Now run the MPU utility. When this utility starts, it should turn the printer on. If the printer will not turn on, check the com port and cable. Now select option 2 (Get printer status) from the menu. If there is no response, you probably have mismatched baud rates.
- Q.** *There seems to be missing or garbled characters sent to the printer.*
- A.** Some systems may alter characters before they are sent to the printer. The '\ ' character for example may

APPENDIX A (continued)

be taken as an escape for the following character. You can place the printer in a 'DUMP' mode to see exactly what characters are being received. In this mode, any character that comes into the printer is printed in both its ASCII form and as a hex value. To place the printer in dump mode, turn the printer off, hold down the FEED key, and turn the printer on. When a report begins to print, release the feed key. After the first report there will be a pause, then a second report. At the end of this report, you will have about 3 seconds to press the feed key to enter Communications Diagnostic (DUMP) Mode. (Refer to pg. P1-6) If you are successful, you will see the message "Dump Mode Entered" on the label along with the Com port settings. You can now send your data to the printer, then examine the resulting label to determine if all characters received are as expected.

Q. *The labels I am producing have fields missing, but the command syntax to produce these fields seems to be correct.*

A. Insure that the entire text or barcode fields you are trying to print are positioned within the label borders when printed. Some commands will print the requested field only if it will 'fit' on the label. Also insure that the requested font and size specified in your label file is resident in the printer. Some applications make use of the flash file system to store custom fonts. If these fonts are missing, the result is a blank field. This also applies for any .PCX image files that may be used in your label files.

APPENDIX B- Interface Cables

BIDIRECTIONAL SERIAL INTERFACE CABLE

Part Number BL13402-1

Use only with Bravo printers configured with standard DB9 serial I/O connector

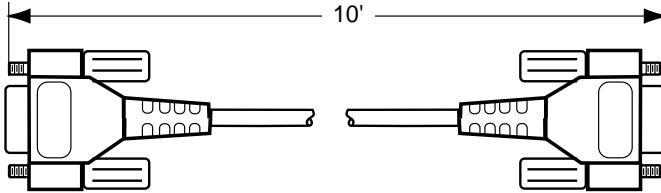

Signal Names

1 ←	(Vcc)	→ 1
2 ←	(TXD)	→ 2
3	(RXD)	→ 3
4	(DSR)	→ 4
5 ←	(GND)	→ 5
6 ←	(DTR)	→ 6
7	(CTS)	→ 7
8 ←	(RTS)	→ 8
9	No Connect	→ 9

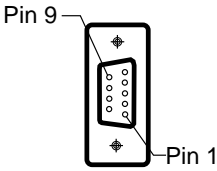

DB-9 Pin
Female Plug
(to PC)

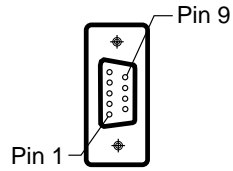

DB-9 Pin
Male Plug
(to Printer)

UNIDIRECTIONAL PARALLEL INTERFACE CABLE

Part Number BL13403-1

Use only with printers configured with parallel Centronics type I/O connector

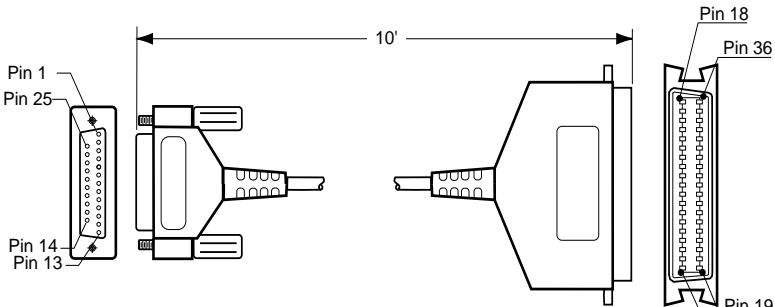

DB-25 Pin
Male Plug
(to PC)

Centronics 36 Pin
Male Plug
(to printer)

APPENDIX B (continued)

BIDIRECTIONAL SERIAL INTERFACE CABLE

Part Number BL11757-000

8-Pin DIN to 9-Pin DB PC Cable

Use to connect all Zebra Mobile Printers to a P.C.

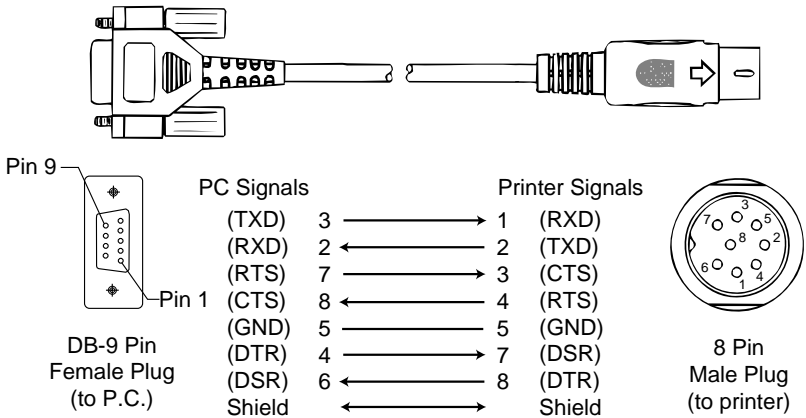

Part Number BL16555-1 (Molded Right Angle DIN Housing to 9-Pin DB)

(For use on QL Series Printers)

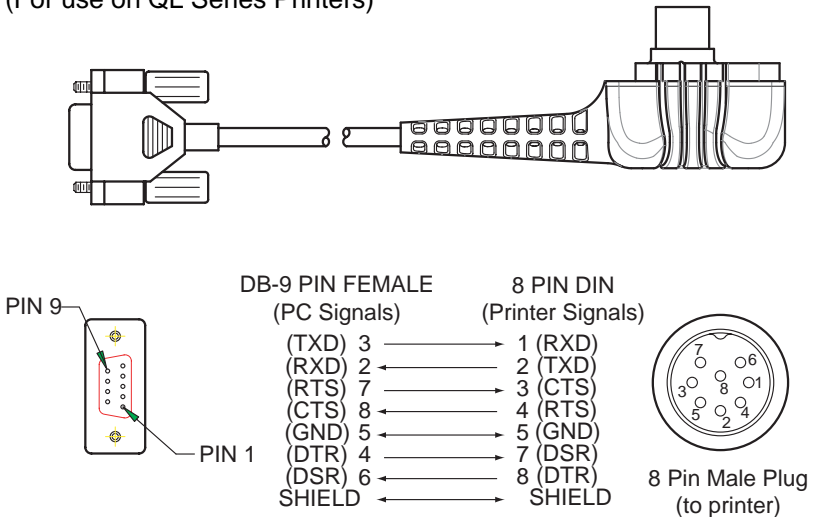

APPENDIX B (continued)

INTERFACE CABLES

Terminal	Cable Part Number	Cord Lgth/Type	Terminal Connector	Printer Connector	Notes
COMPSEE Apex II LXE	BL12093-3	8' Coiled	RJ45	8 Pin DIN	
	BL17757-000	6'/Straight	9 Pin DB	8 Pin DIN	
	BL17757-000	6'/Straight	9 Pin DB	8 Pin DIN	
	BL12093-1	8'/Coiled	RJ45	8 Pin DIN	Power On/Off (+5V)
NORAND	RT1100/1700 Series	8' /Coiled	6 Pin MiniDIN	8 Pin DIN Over-molded	
	RT1100/1700 Series	12'/Coiled	6 Pin MiniDIN	8 Pin DIN Over-molded	
	RT5900 Series	8' /Coiled	15 Pin D-Sub	8 Pin DIN	
	RT1100/1700 Series	8' /Coiled	6 Pin MiniDIN	8 Pin DIN -Locking	
	RT1100/1700 Series	8' /Coiled	6 Pin MiniDIN	8 Pin DIN Over-molded	Auto ON/OFF
	RT1100/1700 Series	8' /Coiled	6 Pin Mini DIN	8Pin DIN	Auto ON/OFF
	6400	6'/Straight	9 Pin DB	8 Pin DIN	
	SYMBOL	PDT3300 Series	8' /Coiled	DB25 male	8 Pin DIN
PDT4100 Series		6' /Straight	9 Pin DB Fem.	8 Pin DIN	Adapter - Symbol PN#25-12059-01
PDT3100/3500 /6100 Series		8' /Coiled	RJ45	8 Pin DIN	a. Power On/Off (+5V) b. Used for the Percon Falcon
PDT3100 Series		8' /Coiled	RJ45	8 Pin DIN	Power On/Off (DTR Line)

APPENDIX B (continued)

INTERFACE CABLES

Terminal	Cable Part Number	Cord Lgth/Type	Terminal Connector	Printer Connector	Notes
SYMBOL (CONT.)					
SPT1700 Series	BL15483-1	9' / Coiled	Cradle	8 Pin DIN	No Power On/Off (DTR Line)
SPT2700 Series	BL15482-1	9' / Coiled	Cradle	8 Pin DIN	Power On/Off (DTR Line)
LRT/LDT3800 Series	CC11371-3	6' / Coiled	PIM Optical	8 Pin DIN	"S" Printers Only
LRT/LDT3800 Series (2 Way)	CC11371-14	6' / Coiled	PIM Optical	8 Pin DIN	"S" Printers Only
LRT/LDT3800 & 6800 Series	CC11371-14	6' / Coiled	PIM Optical	8 Pin DIN	"S" Printers Only
LRT/LDT3800 & 6800 Series	CC11371-15	6' / Coiled	PIM Optical	8 Pin DIN	"S" Printers Only
TEKLOGIC					
7030 ILR	BL13285-2	Coiled	36 Pin IDC Fem	8 Pin DIN	
7025 ILR	BL13285-1	Coiled	15 Pin DB male	8 Pin DIN	
TELXON					
960	BL11122-1	8' / Coiled	RJ45	8 Pin DIN	
960SL Adapter for BL11122-1	CC13711-1	n/a	n/a	n/a	
960 (BL11122-1) & 960SL (CC13711-1)	CP74005	n/a	n/a	n/a	
960	BL12996-1	8' / Coiled	RJ45	8 Pin DIN-Locking	
860 & 912	CL11314-000	8' / Coiled	DB25	8 Pin DIN	

APPENDIX B (continued)

DENSO BHT CABLE INTERFACE

BHT- 3 Pole
Mini-Stereo Plug

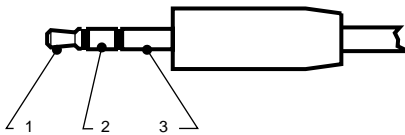

BHT Signal Names

Printer- 8 Pin
Male DIN Plug

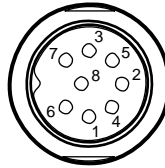

Printer Signal Names

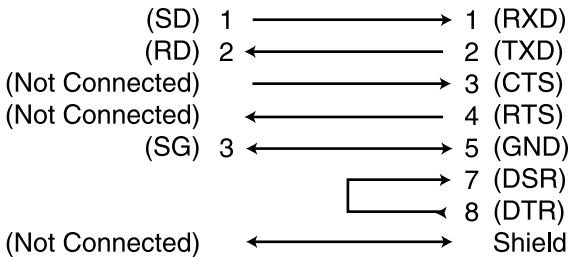

APPENDIX C- Character Tables

ASCII TABLE HEX VALUES

Hex	2	3	4	5	6	7	8	9	A	B	C	D	E	F
0	sp	0	@	P	`	p								
1	!	1	A	Q	a	q								
2	"	2	B	R	b	r								
3	#	3	C	S	c	s								
4	\$	4	D	T	d	t								
5	%	5	E	U	e	u								
6	&	6	F	V	f	v								
7	'	7	G	W	g	w								
8	(8	H	X	h	x								
9)	9	I	Y	i	y								
A	*	:	J	Z	j	z								
B	+	;	K	[k	{		¢						
C	,	<	L	\	l									
D	-	=	M]	m	}								
E	.	>	N	^	n	~								
F	/	?	O	_	o									

INTERNATIONAL ISO SUBSTITUTION CHARACTERS

This table references the ISO symbol set substitutions performed for various countries. The ISO symbol set contains the same characters as the ASCII symbol set except for the character values listed in the table.

---Country---	----HEX Character Values----											
	23	24	40	5b	5c	5d	5e	60	7b	7c	7d	7e
USA	#	\$	@	[\]	^	~	{		}	~
United Kingdom	£	\$	@	[\]	^	~	{		}	-
France	£	\$	ã	°	ç	§	^	μ	é	ù	è	"
Germany	#	\$	§	Ä	Ö	Ü	^	~	ä	ö	ü	ß
Italy	£	\$	§	°	ç	é	^	ù	à	ò	è	ì
Sweden	#	¤	É	Ä	Ö	Å	Ü	é	ä	ö	å	ú
Spain	£	\$	§	¡	Ñ	¿	^	~	°	ñ	ç	~
Norway	#	\$	@	Æ	Ð	Å	^	~	æ	Ý	å	-

APPENDIX C (continued)

CP-850 CHARACTER SET

Hex	2	3	4	5	6	7	8	9	A	B	C	D	E	F
0		0	@	P	˘	p	Ç	É	á			ð	ó	
1	!	1	A	Q	a	q	ü	æ	í			Ð	ß	±
2	"	2	B	R	b	r	é	Æ	ó			Ê	Ô	
3	#	3	C	S	c	s	â	ô	ú			Ë	Ö	
4	\$	4	D	T	d	t	ä	ö	ñ			È	Ø	
5	%	5	E	U	e	u	à	ò	Ñ	Á		ı	Õ	š
6	&	6	F	V	f	v	â	û	•	Â	ã	Í	μ	
7	'	7	G	W	g	w	ç	ü	°	Ã	Ä	Î	þ	,
8	(8	H	X	h	x	ê	ÿ	¿	©		Ï	ƒ	°
9)	9	I	Y	i	y	ë	ÿ	®				Ú	¨
A	*	:	J	Z	j	z	è	Û	¬				Û	•
B	+	;	K	[k	{	ï	ø					Ü	
C	,	<	L	\	l		î	ƒ					Ý	
D	-	=	M]	m	}	ï	ø	ı	ç			Ý	
E	.	>	N	^	n	~	Ä		«	¥		Ï	-	
F	/	?	O	_	o		Å		»		¤		´	

APPENDIX C (continued)

LATIN 1 CHARACTER SET

Hex	2	3	4	5	6	7	8	9	A	B	C	D	E	F
0		0	@	P	ˆ	p				°	À	Ð	à	ð
1	!	1	A	Q	a	q			ı	±	Á	Ñ	á	ñ
2	"	2	B	R	b	r			¢		Â	Ò	â	ò
3	#	3	C	S	c	s			£		Ã	Ó	ã	ó
4	\$	4	D	T	d	t			¤	˘	Ä	Ô	ä	ô
5	%	5	E	U	e	u			¥	µ	Å	Õ	å	õ
6	&	6	F	V	f	v					Æ	Ö	æ	ö
7	'	7	G	W	g	w			§	•	Ç	×	ç	÷
8	(8	H	X	h	x			"	,	È	Ø	è	ø
9)	9	I	Y	i	y			©	ı	É	Ù	é	ù
A	*	:	J	Z	j	z			ª	º	Ê	Ú	ê	ú
B	+	;	K	[k	{			«	»	Ë	Û	ë	û
C	,	<	L	\	l				¬		Ï	Ü	ï	ü
D	-	=	M]	m	}					Í	Ý	í	ý
E	.	>	N	^	n	~			®		Î	Þ	î	þ
F	/	?	O	_	o				¯	¿	Ï	ß	ï	ÿ

APPENDIX D - Font Information

FONT HEIGHTS

The following table contains the font heights. The height values are in pixels.

Font # / Font Size --->	0	1	2	3	4	5	6	7
0	9	9	18	18	18	36	36	
1	48							
2	12	24						
4	47	94	45	90	180	270	360	450
5	24	48	46	92				
6	27							
7	24	48						

FIXED-WIDTH FONTS

The following table contains the font widths for the fixed-width fonts. Only one width is given for each font/size combination since every character in that font/size combination has the same width. The proportional-width fonts follow, with a separate table for each. The space character will be substituted for empty values in these tables. The width values are in pixels.

Font # / Font Size --->	0	1	2	3	4	5	6	7
0	8	16	8	16	32	16	32	
1 (see separate table)								
2	20	20						
4 (see separate tables)								
5 (see separate tables)								
6	28							
7	12	12						

APPENDIX D (continued)

PROPORTIONAL WIDTH FONTS

FONT WIDTH IN DOTS-FONT 1, SIZE 0

Hex	2	3	4	5	6	7	8	9	A	B	C	D	E	F
0	15	19	22	26	29	15								
1	17	16	26	26	17	15								
2	19	23	26	26	16	11								
3	21	20	20	23	15	16								
4	21	20	25	28	19	12								
5	23	23	22	25	14	18								
6	23	21	20	23	12	16								
7	10	22	18	28	17	23								
8	14	21	23	25	16	16								
9	19	19	16	20	9	18								
A	17	8	21	25	8	17								
B	18	13	24	16	16	13		14						
C	10	19	17	26	11	14								
D	20	21	28	12	26	13								
E	10	18	26	27	17	13								
F	17	19	23	24	15									

FONT WIDTH IN DOTS-FONT 4, SIZES 0-1

Hex	2	3	4	5	6	7	8	9	A	B	C	D	E	F
0	12	23	43	28	14	24								
1	13	23	28	32	24	24								
2	15	23	29	30	24	15								
3	23	23	30	27	22	21								
4	23	23	30	26	24	13								
5	37	23	28	29	23	23								
6	28	23	26	27	13	21								
7	8	23	32	39	24	30								
8	14	23	30	27	23	21								
9	14	23	12	28	10	21								
A	17	11	21	25	10	20								
B	25	11	28	12	22	14		23						
C	11	25	23	12	10	12								
D	14	25	35	12	35	14								
E	11	25	31	21	23	25								
F	12	24	32	23	24									

APPENDIX D (continued)

FONT WIDTH IN DOTS-FONT 4, SIZES 2-7

Hex	2	3	4	5	6	7	8	9	A	B	C	D	E	F
0	26	51			31									
1	31	51												
2	44	51												
3		51												
4	40	51												
5	82	51												
6		51												
7	22	51												
8	31	51												
9	31	51												
A	36	31												
B	54	31						40						
C	26	54				26								
D	31	54												
E	26	54												
F	26	56												

FONT WIDTH IN DOTS-FONT 5, SIZES 0-1

Hex	2	3	4	5	6	7	8	9	A	B	C	D	E	F
0	6	12	23	15	8	14								
1	8	12	18	19	12	14								
2	12	12	16	18	13	11								
3	13	12	18	14	11	10								
4	12	12	18	16	14	8								
5	19	12	17	18	11	14								
6	21	12	15	18	8	12								
7	7	12	19	24	12	18								
8	8	12	19	18	14	12								
9	8	12	10	18	7	12								
A	13	8	12	17	7	11								
B	14	8	19	8	15	10		14						
C	10	14	16	7	7	5								
D	16	14	24	8	21	10								
E	10	14	18	10	14	10								
F	7	12	19	12	13									

APPENDIX D (continued)

FONT WIDTH IN DOTS, FONT 5, SIZES 2-3

Hex	2	3	4	5	6	7	8	9	A	B	C	D	E	F
0	12	21	39	23	14	22								
1	14	21	30	30	20	22								
2	17	21	28	28	22	15								
3	21	21	28	23	18	16								
4	21	21	30	25	22	13								
5	35	21	26	30	19	22								
6	33	21	23	30	14	21								
7	10	21	30	40	20	30								
8	14	21	31	30	22	21								
9	14	21	15	30	12	21								
A	21	12	17	26	12	18								
B	24	12	30	14	21	20		21						
C	11	24	26	12	11	8								
D	14	24	37	14	33	20								
E	11	24	30	20	22	22								
F	12	19	30	21	21									

APPENDIX E-BARCODE QUICK REFERENCE

Barcode Symbology	Barcode Type	Input Length	Characters	Ideal Wide/Narrow Ratio	Ideal Narrow Dot Width	Checksum Calculation
UPC-A	UPCA	11 or 12 digits*	0-9 only	2:1	2	mod 10
UPC-A plus 2	UPCA2	13 digits*	0-9 only	2:1	2	mod 10 (UPC-A)
UPC-A plus 5	UPCA5	16 digits*	0-9 only	2:1	2	mod 10 (UPC-A)
UPC-E	UPCE	6, 7 or 11 digits*	0-9 only	2:1	2	mod 10
UPC-E plus 2	UPCE2	8 or 13 digits*	0-9 only	2:1	2	mod 10 (UPC-E)
UPC-E plus 5	UPCE5	11 or 16 digits*	0-9 only	2:1	2	mod 10 (UPC-E)
EAN/JAN-13	EAN13	12 or 13 digits*	0-9 only	2:1	2	mod 10
EAN/JAN-13 plus 2	EAN132	14 digits*	0-9 only	2:1	2	mod 10 (EAN13)
EAN/JAN-13 plus 5	EAN135	17 digits*	0-9 only	2:1	2	mod 10 (EAN13)
EAN/JAN-8	EAN8	6, 7 or 8 digits*	0-9 only	2:1	2	mod 10
EAN/JAN-8 plus 2	EAN82	9 digits*	0-9 only	2:1	2	mod 10 (EAN8)
EAN/JAN-8 plus 5	EAN85	12 digits*	0-9 only	2:1	2	mod 10 (EAN8)
Code 39 (3 of 9)	39	Variable	See notes*	2.5:1	2	none
	39C	Variable	See notes*	2.5:1	2	mod 43
	F39	Variable	See notes*	2.5:1	2	none
	F39C**	Variable	See notes*	2.5:1	2	mod 43
Code 93 (9 of 3)	93	Variable	128 ASCII	1.5:1	1	two mod 47
Interleaved						
2 of 5	I2OF5	See notes*	0-9 only	2.5:1	2	See notes*
Interleaved 2 of 5						
w/check digit	I2OF5C	See notes*	0-9 only	2.5:1	2	mod 10
Industrial						
2 of 5	2OF5	See notes*	0-9 only	2.5:1	2	See notes*
Industrial 2 of 5 w/ check digit	2OF5C	See notes*	0-9 only	2.5:1	2	mod 10
Code 128						
/A/B/C/Auto	128	Variable	See notes*	1.5:1	1	mod 103
UCC-128Std.	UCCEAN	See notes*	See notes*	3:1	3	mod 103
Codabar	CODABAR	Variable	0-9,A-D symbol	2.5:1	2	none
	CODABAR 16	Variable	0-9,A-D, symbol	2.5:1	2	mod 16

APPENDIX E (CONTINUED)

Barcode Symbology	Barcode Type	Input Length	Characters	Ideal Wide/Narrow Ratio	Ideal Narrow Dot Width	Checksum Calculation
MSI Plessey	MSI	13 digits max	0-9 only	2:1	2	none
	MSI10	13 digits max	0-9 only	2:1	2	mod 10
	MSI1010	13 digits max	0-9 only	2:1	2	two mod 10
	MSI1110	13 digits max	0-9 only	2:1	2	mod 11 mod 10
Postnet	POSTNET	5, 9, 11 digits	0-9 only	3.5:1	3	mod 10
Facing						
Ident Mark	FIM	A, B, or C only	A, B, or C	1.5:1	6	N/A

* Refer to the discussion of this particular barcode in Section Five for more information.

**To make a HIBCC compliant bar code, use bar code type F39C. See the document "The Health Industry Bar Code (HIBC) Supplier Labeling Standard" from the Health Industry Business Council, 5110 N. 40th Street, Suite 250, Phoenix, Arizona 85018.

MEDIA SUPPLIES

To insure maximum printer life and consistent print quality and performance for your individual application, it is recommended that only media produced by Zebra be used. These advantages include:

- Consistent quality and reliability of media products.
- Large range of stocked and standard formats.
- In-house custom format design service.
- Large production capacity which services the needs of many large and small media consumers including major retail chains world wide.
- Media products that meet or exceed industry standards.

For more information call Zebra Technologies Corporation at 1-866-230-9495 and ask to speak to a Media Sales Representative.

MAINTENANCE SUPPLIES

In addition to quality media provided by Zebra, it is recommended that the print head be cleaned as prescribed in the User's Manual for individual models. The following items are available for this purpose:

- Print Head Cleaning Pads (10 pack),
Reorder No. AN11207-1
(For use with all Zebra mobile printers.)
- Print Head Cleaning Cards (10 pack),
Reorder No. AN11208-1
(Recommended for use with MP50XX, M2, and M4 printers.)
- Cleaning Kit with Alcohol, Cleaning Card, and Cotton Swabs, Reorder No. AT700
(Recommended for use with MP50XX, M2, and M4 printers.)
- Cleaning Kit with Alcohol, Cleaning Pad, and Cotton Swabs, Reorder No. AT700-2
(Recommended for use with RP3 printer.)
- Cleaning Kit with Cleaning Pen and (5) Cleaning Swabs, Reorder No. AT702-1
(Recommended for use with Bravo and QL series printers)
- Cleaning Pen 10 Pack, Reorder No. AN11209-1
(Recommended for use with all Zebra mobile printers.)

TECHNICAL SUPPORT

Contact the Help Desk at:

Zebra Technologies Corporation
30 Plan Way
Warwick, Rhode Island 02886-1012 USA
Telephone: +1 401.739.5800
Fax: +1 401.732.7808
E Mail: risupport@zebra.com

In Europe:

Zebra Technologies Europe, Ltd.
Zebra House
The Valley Centre, Gordon Road
High Wycombe
Buckinghamshire HP13 6EQ, United Kingdom
Telephone: +44 (1) 494 768298
FAX: +44 (1) 494 768210
e-mail: tseurope@zebra.com

Ask for Customer Support



Technical Support: +1 847.793.2600 or +1 800.423.0442

www.zebra.com

Zebra Technologies Corporation

Mobile Printer Center of Excellence
30 Plan Way
Warwick, RI 02886-1012 U.S.A.
phone: + 1 401.739.5800 or + 1 800.556.7266
fax: + 1 401.732.7808

Zebra Technologies Europe Limited

Zebra House
The Valley Centre, Gordon Road
High Wycombe
Buckinghamshire HP13 6EQ, UK
phone: + 44 (0) 1494 472872
fax: + 44 (0) 1494 450103